



THE BLACK VAULT

This document was obtained from The Black Vault, an online database of declassified government documents. This particular record is housed in the MKULTRA/Mind Control Collection, a compilation of more than 20,000 pages declassified by the Central Intelligence Agency (CIA).

The entire collection is free to download and online at:

<http://mkultra.theblackvault.com>

INVESTIGATION OF ELECTRIC FISHES

FINAL REPORT - PHASES 1 AND 2

by

Prepared under
Contract

August 1974

SUMMARY

Electric fishes have one or more transmitting electric organs and an array of electroreceptors. The system is controlled by special nuclei located in the brain. The elements of the electric transmitting organs, called electroplates, are described; and the electromotive force (EMF) generated by each electroplate and of the entire organ is discussed. The waveform of the signals was studied and the structure of the electric organs investigated. The biochemistry of the neurotransmitter and the metabolism of the electrogenic tissue is discussed. The physiology of the electric transmitting organs was studied, and their common properties described. Analogy has been made between the electrogenic properties of muscular tissue and the electric organs of fishes. The transversal and lateral resistance of the electric tissue of the electric eel and torpedo is mentioned.

Electroreceptors are special sensors of the lateral line system. Some fishes possess electroreceptors and no electric transmitting organ. The different kind of electroreceptors are mentioned. The physiology of some of the electroreceptors of Sternarchus albifrons, a South-American fresh water weakly electric fish were investigated. The electroreceptors of the mormyrid Gnathonemus petersii were mapped and counted.

Tonic and phasic electroreceptors were studied. The nervous control and function of the electroreceptors is discussed and the functional characteristics of six different kinds of lateral line organs have been considered.

The location of objects by the electroreceptor system of electric fish is discussed and communication between electric fishes mentioned.

The electric field pattern around the electric fish Sternarchus albifrons has been plotted and compared with the theoretical pattern of a dipole. The perturbing effects of various confinement cages on the electromagnetic field pattern were determined. Distortions of the wave form with distance were recorded.

The maximum detection range of the electric fishes Gnathonemus sp. and Gymnotus carapo to stainless steel, iron, brass and nylon is presented. At the critical separation between the fish and sample, (assumed to be the threshold detection distance) the fish increased the rate of its signals or ceased transmission entirely. The effects of sample material, sizes, form and azimuth on the threshold detection distance are presented. Behavioral experiments have been formed using Gymnarchus niloticus to determine the threshold of detection distances. These experiments were also performed in the fiberglass tank with and without an aluminum foil liner. Photos and movie films were made to record the fishes behavior.

Gnathonemus sp. is a fresh water, low rate, high frequency pulse weak electric African mormyrid fish. Gymnotus carapo is a fresh water, medium rate, medium frequency pulse, weak electric South-American gymnotid fish. Despite their physiological and electric differences, both these fishes stopped transmitting electric signals if the object was of high conductance and was brought close to the fish (< 50 cm). Because the fishes were very excited and tried to escape even after they had ceased transmitting, it seems reasonable to assume that they continue to detect the objects in the water using their sensors in a passive mode.

The electroreceptors of Gnathonemus sp. were mapped to location and morphological type and related to the area. We recorded the response of some electroreceptors of Gnathonemus sp. The presence of one type of receptor in the sensor matrix which is sensitive to mechanical movement was established.

A qualitative assessment of the fishes ability to navigate within a difficult maze of nylon fishing line has been made. Blind electric fishes (Gymnarchus niloticus, Sternarchus albifrons, and Gymnotus carapo) easily navigate through such mazes. Photos and movie film were made. These behavior experiments were performed in a 12 foot diameter fiberglass tank and under two separate electric boundary conditions.

The threshold sensitivity for detection of a magnetic field is presented in graphic form for: Gymnarchus niloticus, Sternarchus albifrons and Gnathonemus sp. Photos were made and the behavior of the fishes has been filmed.

The threshold detection limits of Gymnarchus niloticus and Gnathonemus sp. was determined for a D.C. electric field under two different electrical boundary conditions. The reactions of Gymnarchus niloticus, Gnathonemus sp. and Sternarchus albifrons, to recordings of their own electrical signals and to those of other individuals of the same species are presented under two very different electrical backgrounds. Photos and movie films were taken.

We arrived at the conclusion that our knowledge of electroreceptors arrays and lateral line sensory receptors of electric fishes is incomplete. Investigation in their function and biochemical composition would put us in the position of designing systems having similar properties with electric fishes for underwater detection, location and identification of objects. The importance of neurotransmitters is stressed and the role of electric fishes in the study of these complex energetic systems is mentioned. Electric fishes offer some unique properties in the study of electrophysiology and neurochemistry.

CONTENTS

1.	INTRODUCTION	1
2.	TECHNICAL DISCUSSION	6
2.1	THE TRANSMITTING ELECTRIC ORGANS OF ELECTRIC FISHES	6
2.1.1	The Electromotive Force of Electric Organs ..	6
2.1.2	The Waveform of Electric Signals	6
2.1.3	The Structure of the Electric Organs	12
2.1.4	Chemical Composition of the Chemotransmitter and the Metabolism of the Electrogenic Tissue .	12
2.1.5	Physiology of the Electric Organ	22
2.2	ELECTRORECEPTORS AND ELECTRORECEPTION ..	30
2.2.1	Distribution of the Electrosensory Receptors ..	32
2.2.2	Tonic and Phasic Electroreceptors	36
2.2.3	The Control and Function of the Electro- receptors	44
2.2.4	Active Electroreception	49
2.2.5	Passive Electroreception	51
2.2.6	Coding of the Electrical Signal of Electric Fishes	52
2.3	EXPERIMENTAL FINDINGS	53
2.3.1	Methods	53
2.3.2	The Electromagnetic Field Generated by <u>Sternarchus albifrons</u> a South American Fresh <u>Water Weakly Electric Fish</u>	57

CONTENTS (Cont'd.)

2.4	BEHAVIOR EXPERIMENTS FILMED ON STANDARD 8 FILM	77
2.4.1	Experiments Needed to Assess Sensitivity, Range and Effectiveness of the Electric Fishes to Detect Objects and Communicate Under- water	77
2.5	BEHAVIORAL EXPERIMENTS USING PHYSIOLOGICAL METHODS	94
3.	CONCLUSIONS AND RECOMMENDATIONS	96
	REFERENCES	99

1. INTRODUCTION

In this final report we would like to mention and summarize the morphological, physiological and behavioral aspects of some electric fishes. Darwin⁽¹⁾ and Dahlgreen⁽²⁾ consider the electric organs of fishes as a difficult case to be explained by what evolutionary steps they may have been produced. Except the lung-snail Daudebardia from Asia Minor which has been reported as electrogenic by Leder and mentioned by Garten,⁽³⁾ the only class in the animal kingdom known to possess specialized electric organs is the class of fishes. The electric transmitting organs are derived in most electric fishes from modified muscular tissue. We observed this fact in Gymnarchus niloticus, an African fresh-water weakly electric fish. But there are exceptions like the South American fresh-water weakly electric fish Sternarchus albifrons, whose transmitting electric organ is derived from modified nervous tissue. Mutations by virtue of change enhanced the survival and fitness of the organism, giving it a superiority over the other species either in communication, in navigation, or food finding and defense against enemies. Because the successive mutations stand the test of natural selection, they produced an organism greatly different from its distant forebears.

Communication in its large interpretation encompasses any information needed to produce a change in a state. Change from one state into another raises entropy, and energy is needed to raise the state from one level to the other. Compared with the complete electrochemical communication system of the electric fishes, all others used by living organisms are less efficient. By its nature, the nervous system uses electrical impulses as a

communication means. In order to communicate and use a language, human beings have to transform electrical and chemical energy into mechanical and acoustical energy for transmitting messages and to transform optical, acoustical, or mechanical energy into electrical and chemical energy for receiving messages. Always energy is lost and entropy is raised.

Electric fishes are the only ones which use only electrochemical energy for communication purposes with minimum loss in energy and minimum rise in entropy. Fishes can communicate reliably underwater, but we have difficulties in doing this although we dispose of energies many orders of magnitude larger than those used by fishes.

For this reason and for their ability to use their electrosensory system for detection, identification and location of underwater objects it seemed appropriate to study some of the electric fishes, their transmitting organs and their electroreceptors. An investigation has been conducted for the [redacted] for a period of three years which resulted in a final report. Behavioral and physiological experiments have been conducted by the author on the Electrophoridae, Sternarchidae, Gymnotidae, Mormyridae, Gymnarchidae, and Malapteruridae. Other investigators have studied the physiology, the morphology and behavior of a few species of electric fishes, but the subject is far from being completely understood. The author studied also the morphology and physiology of electric fishes in connection with the detection and location of objects and underwater communication. For the investigation mostly Sternarchidae were used, but some limited findings in Mormyridae and Gymnarchidae have also been studied. We found that the electric fishes could use their electric organs (transmitting and receiving) for navigation and communication-- in other words, pattern recognition.

The electric signal recordings and histological evidence indicate that Sternarchus albifrons has three kinds of electroreceptors: ampullary tonic nonsynchronous units, ampullary tonic synchronous units, and tuberos phasic nonsynchronous units. Both are represented by a generator connected to resistances and capacitances in series and in parallel. [The difference between tonic and phasic electroreceptors is that the former have one resistance in series with the generator whereas the phasic electroreceptors have a capacitance. The tonic electroreceptors seem to predominate at a ratio of approximately five-to-one, compared to the phasic electroreceptors. The electroreceptors seem to act, to a certain extent, independently of the main electric transmitting organ; at least two of the three types of electroreceptors are asynchronous. Szabo⁽⁸⁾ found that the complete denervation of the transmitting electric organ does not stop the activity of the asynchronous electroreceptors (both phasic and tonic). The fish is still capable of responding to conductive and nonconductive objects placed near the fish's body. Denervation of the transmitting organ will affect the capability of certain movement or impair, to a certain extent the ability to recognize patterns.] Some of the synchronous tonic units are connected to the same nerve trunk as the acoustico-lateralis system and connected to specialized big nuclei in the brain. ✓

The most striking fact about fresh water weak electric fish, besides their spontaneous electric organ, is that all of them are provided with a highly developed lateralis line system. Related to this acoustico-lateralis system is an enlargement of the cerebellum, especially in Gymnarchus niloticus and in Mormyridae. [The unusual importance of the lateralis system in these fish, compared with other teleosts, is not due to an increased number of "ordinary" lateral line sensory organs, but rather to the existence of a great number of specialized sensory organs within this same system.]

This is supporting our hypothesis about a hybrid complex underwater pattern recognition system used by electric fishes in recognition of prey, predators, and navigation in general. It is recommended that the other lateral line systems from different fresh water weak electric fishes should be studied with the aim to find out the role of the different sensory organs in pattern recognition.

Finer subdivisions exist between the one and the same type of electroreceptor, but this has not been as yet investigated in a detailed way.⁽⁴⁰⁾ Knowledge of the physiology and biochemistry of the electroreceptors are incomplete. These studies will provide a basis for understanding the working of the system. Microelectrode recordings from the electroreceptors proper and from their nerve fibers are needed to provide information concerning the function of the receiving system.

By combining the anatomical and functional data of these fishes it could be possible to simulate an equivalent underwater sensory system. Two double feedback mechanisms are envisaged: (1) a system transmitting a constant frequency electric field and using a phase-synchronous electroreceptor responding to either discontinuities in the electric field or to changes in the phase relationship between the transmitting and receptors; and (2) a second one represented by a variable frequency transmitter and receptor with a change of frequency. An independent dual autorhythmic receptor system could be designed and: (a) increasing or decreasing the autorhythmic frequency depending on the direction of movement of the disturbance in the electric field; and (b) responding with a change in the latency depending on the magnitude of the disturbance, also distinguishing between conductive and nonconductive objects.

In any case the key to the object detection, location and identification by electric fishes is their electrosensory receptors and the other lateral line detectors. The difficulties are multiple: some of the electric fishes are difficult to obtain; are susceptible to diseases; their nutritional requirement is not known; they are often injured and/or subjected to chemical treatments before shipment; and are intolerant of prolonged periods of confined experimentation.

The Phase I Final Report described the location and distribution of electroreceptors and a mechanical receptor of the lateral line system of the African fresh water weakly electric fish Gnathonemus petersii. The auto-rhythmic activity of these electroreceptors has been recorded. The variation of the electric signal of the electric organ has been recorded for three specimens of this species at rest activity and at the maximum signal rate. The number and density of different kinds of electroreceptors in the dermis were counted and their rate change sensitivity to a metallic object recorded.

2. TECHNICAL DISCUSSION

2.1 THE TRANSMITTING ELECTRIC ORGANS OF ELECTRIC FISHES

2.1.1 The Electromotive Force of Electric Organs

In Figs. 1 and 2 some representatives of fresh water and marine electric fishes and their electric organs are shown. Electrophorus electricus and Malapterurus electricus are fresh-water strong electric fishes, the first one attaining a maximum discharge voltage from its main electric organ in excess of 600 volts, the second one only 300 volts. Torpedo nobiliana may discharge a train of pulses close to 220 volts and Astroscopus guttatus may attain 50 volts. The latter two are marine strong electric fishes. Gymnarchus niloticus, Gnathonemus petersii and Sternarchus albifrons are fresh water weakly electric fishes. Raja clavata is a rajid marine weakly electric fish. The electric discharge of some weakly electric fishes out of water may attain 7 to 8 volts, but in the water their voltage is attenuated to less than one volt in the immediate vicinity of the fishes.

2.1.2 The Waveform of Electric Signals

Figures 3 and 4 show the pulse shape and duration of some species of electric fishes. Every species has its own characteristic electric discharge. Electrophorus electricus has three electric organs: the main electric organ, the organ of Hunter and the organ of Sachs. The main electric organ and the spinal cord of Electrophorus are represented in Figs. 5 and 6.

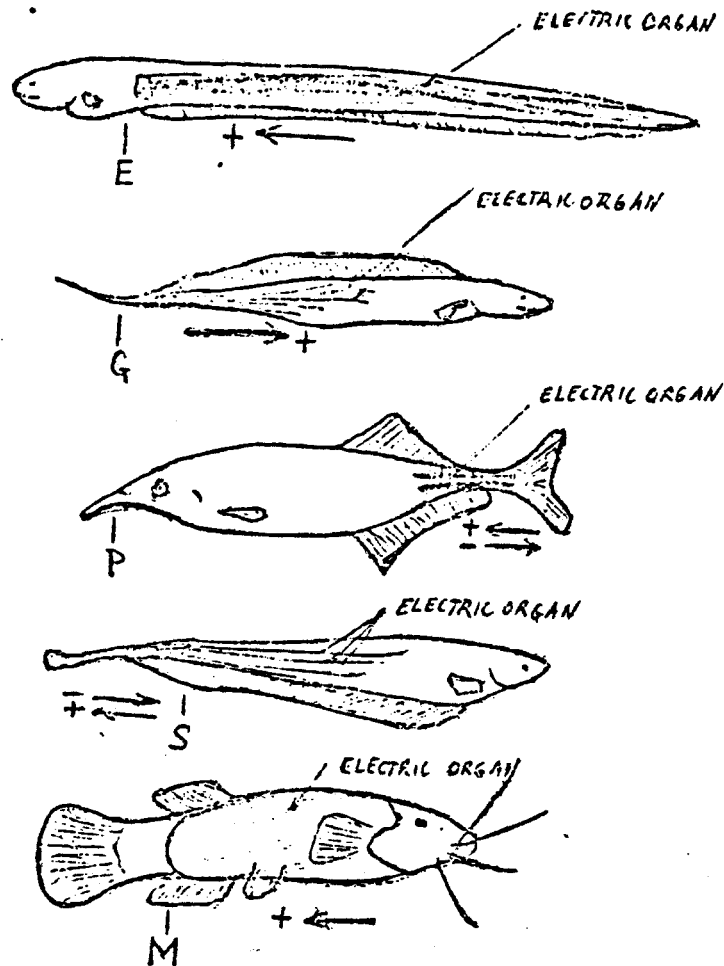

Fig. 1. Principal representatives of fresh-water electric fishes. Arrow indicates direction of current in the electric organs.

- E = Electrophorus electricus (electric eel)
- G = Gymnarchus niloticus
- P = Gnathonemus petersii (elephant-nose)
- S = Sternarchus albifrons (black-ghost)
- M = Malapterurus electricus (electric catfish)

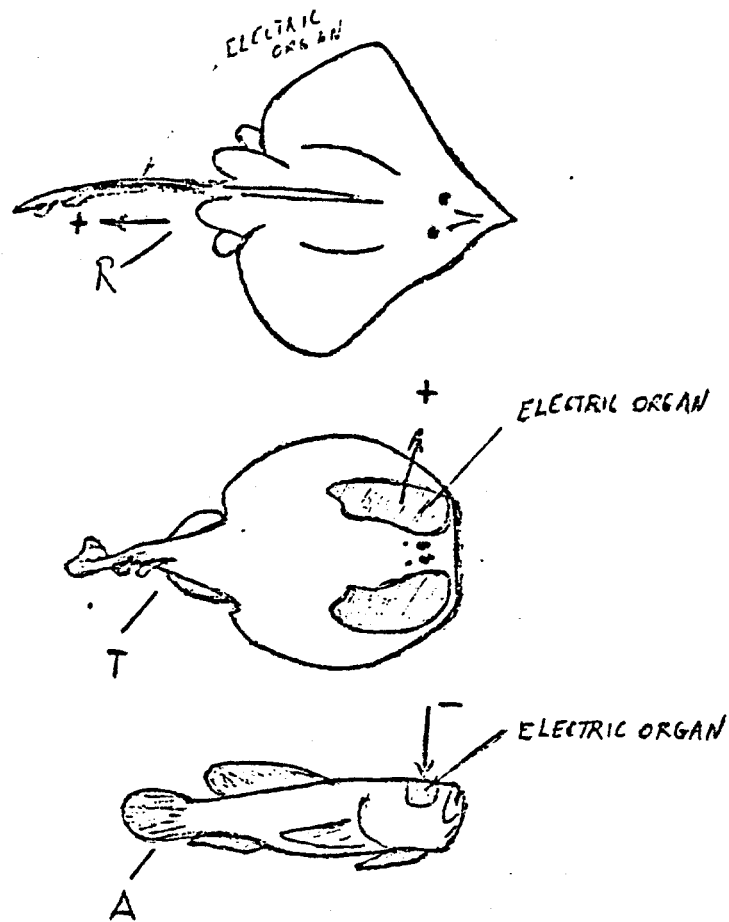

Fig. 2. Principal representatives of marine electric fishes. Arrow indicates direction of current in the electric organs.

R = Raja clavata (thornback ray)

T = Torpedo nobiliana

A = Astroscopus guttatus (stargazer)

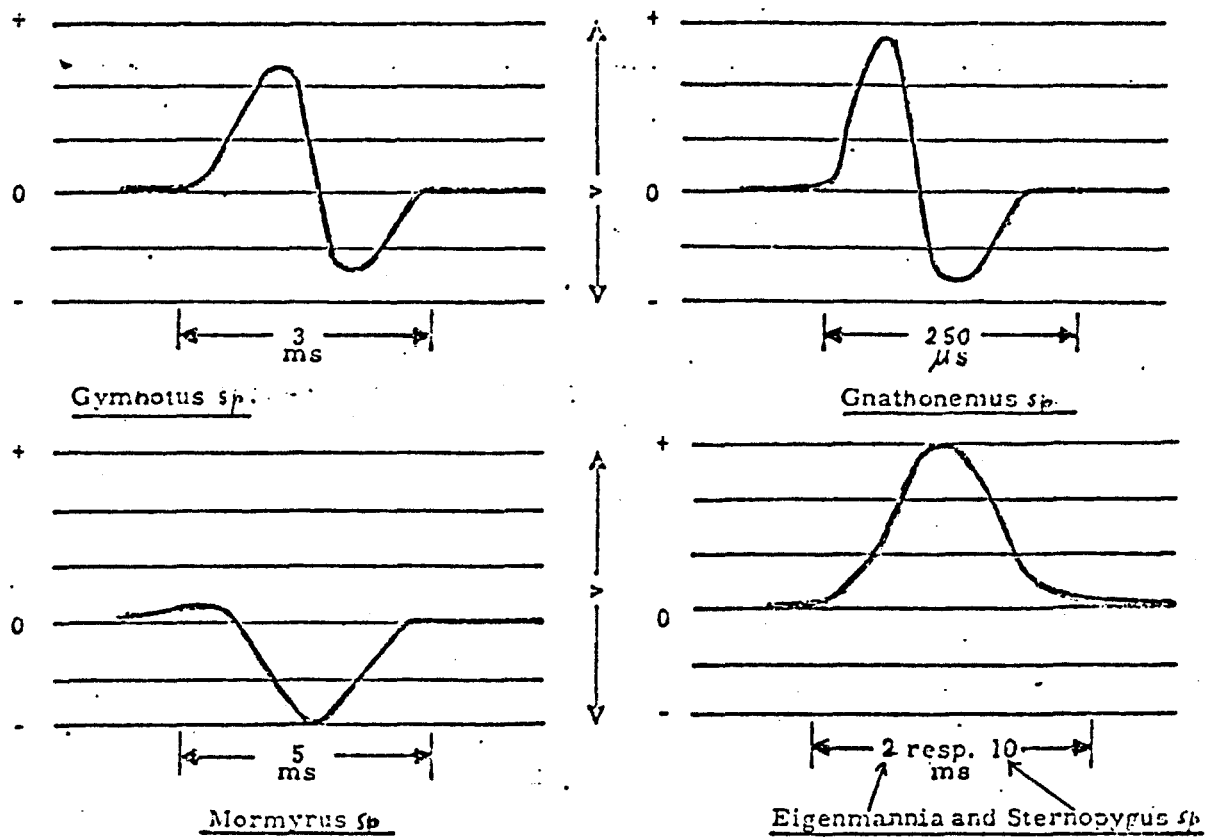

Fig. 3. Pulse shape and pulse duration of some species of electric fishes.

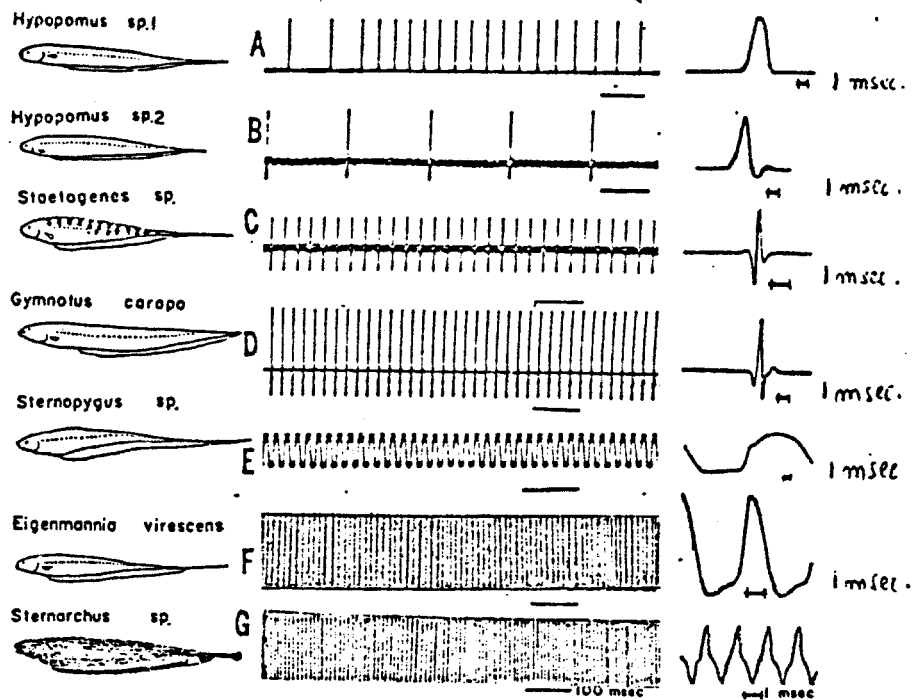

Fig. 4. Discharge of electric organs of some Gymnotidae, Sternarchidae and Ramphichthyidae (redrawn after Hagiwara and Morita⁽⁵⁴⁾).

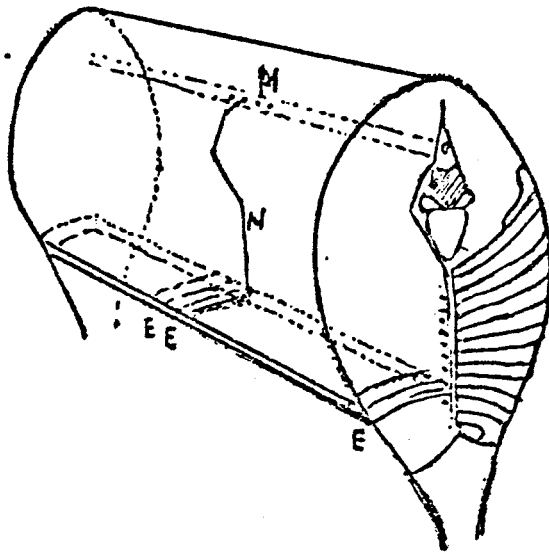

Fig. 5. Tridimensional section of an Electrophorus electricus (electric eel) main electric organ, to show schematically the trajectory of the electric nerves (N) from the big spinal cord cells (M) to the posterior of the electroplates (E). Only a few electroplates are shown (redrawn after A. Fessard⁽¹⁸⁾).

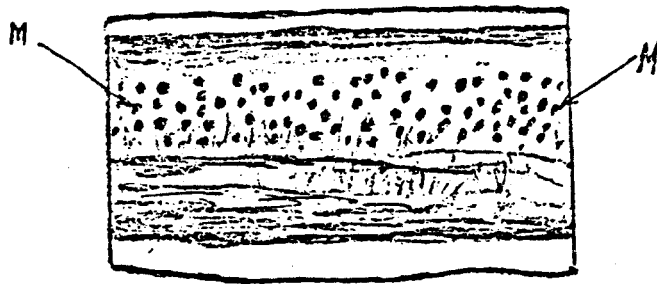

Fig. 6. Spinal cord of Electrophorus electricus showing the big cells of the electric neurons (M).

2.1.3 The Structure of the Electric Organs

The electric organ of Gymnarchus niloticus is shown in Fig. 7. The electric organs of most electric fishes are derived from muscle tissue. Sternarchus albifrons is an exception. Its electric organ is derived from nervous tissue (Fig. 8).

The electric organs of Mormyrus oxyrhynchus and Gnathonemus senegalensis are represented in Fig. 9 and 11. The elementary units or building blocks of electric fishes are called electroplates (or electroplaxes or electrocytes). Some mormyridae electroplates and their innervation are shown in Fig. 10, 12 and 13.

2.1.4 Chemical Composition of the Chemotransmitter and the Metabolism of the Electrogenic Tissue

The chemotransmitter in the electric organs of electric fishes derived from muscle tissue is acetylcholine and its hydrolysis enzyme acetylcholinesterase. The chemotransmitter involved in the electric organ of Sternarchus albifrons (derived from nervous tissue) is not known.

The electric organs of fish are an invaluable tool for studying the biochemical mechanism underlying bioelectricity. The organs are the most powerful bioelectric generators created by nature and, moreover, highly specialized in their function. Most of the electric organs of electric fishes have unique structural features which permit the correlation of the electrical activity with the enzyme activity.⁽¹⁰⁾

Choline acetylase in the presence of ATP (adenosine triphosphate) and of CoA is capable of synthesizing acetylcholine in solution. This enzyme is also present concomitant with acetylcholinesterase in a great variety of conducting tissue, motor and sensory axons, vertebrate and

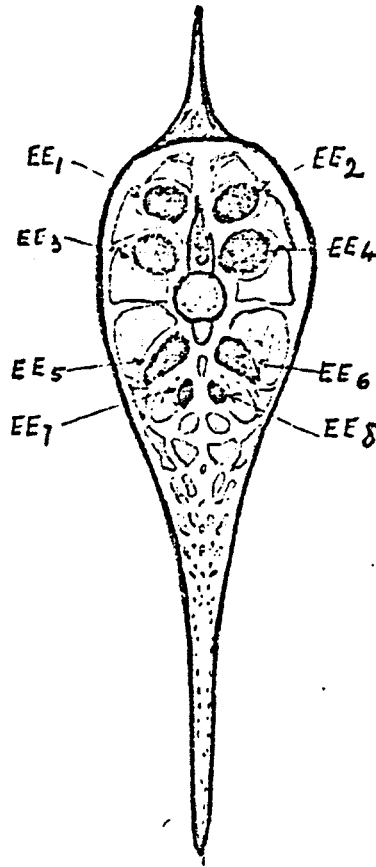

Fig. 7. Transverse section of the posterior half of a Gymnarchus niloticus. The section of the eight electric organs are shown (EE₁ to EE₈) (redrawn after Fritsch).

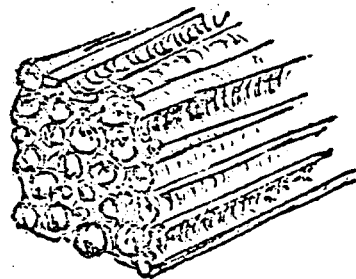

Fig. 8. Tridimensional structure of the electric organ of Sternarchus albifrons.

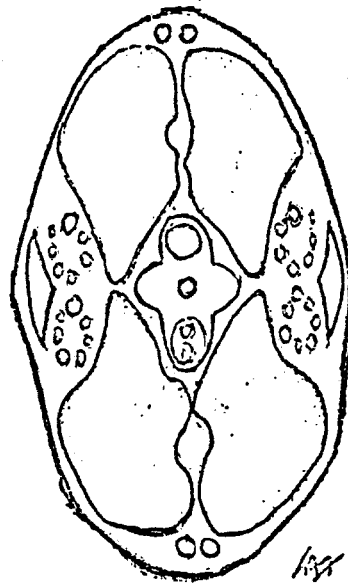

Fig. 9. Mormyrus oxyrhynchus: Caudal cross-section.
The four black sections are electric organs
(redrawn after Marcusen).

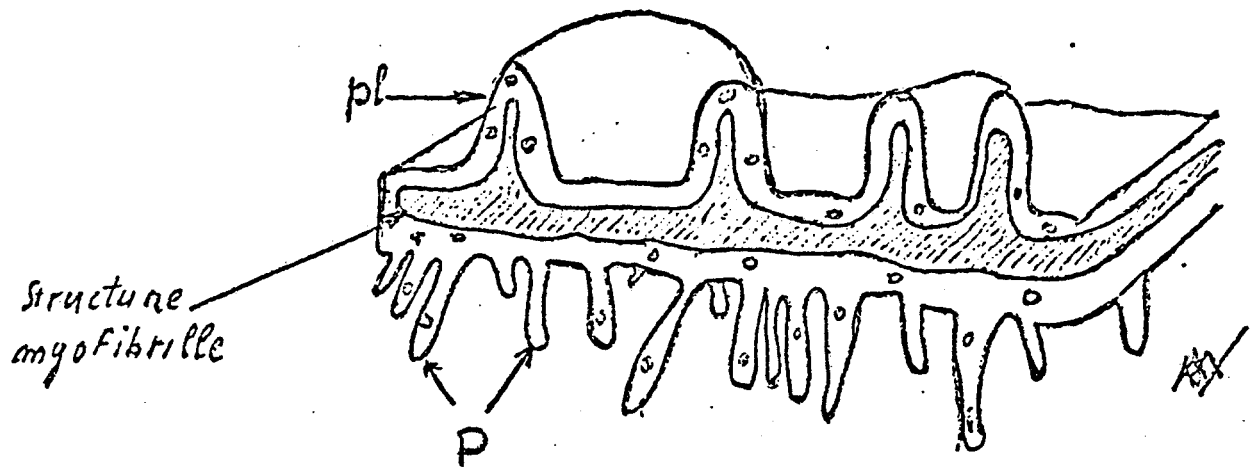

Fig. 10. Semi-schematic representation of an electroplate of *Gnathonemus numenius*. Orientation antero-posterior. (After Th. Szabo - Report to the French Academy of Sciences.)

pl = anterior fold

P = papilla

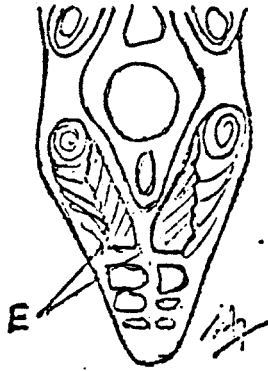

Fig. 11. Gnathonemus senegalensis. (Redrawn after Th. Szabo.) E = electric organs.

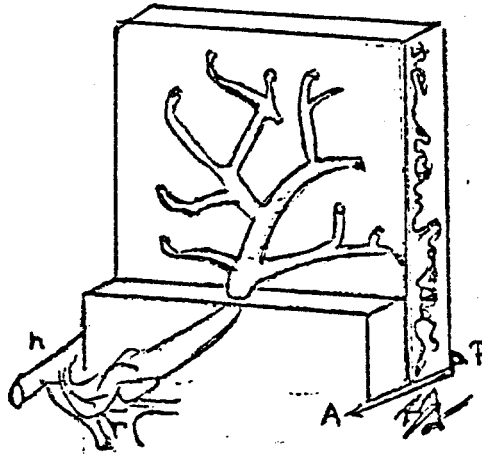

Fig. 12. Electroplate of Gnathonemus. (Redrawn after Th. Szabo.) A = anterior, P = posterior.

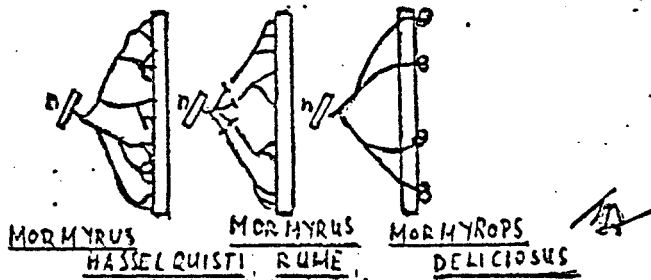

Fig. 13. Electroplates of some Mormyrids. (Redrawn after Th. Szabo.) n = nerve trunk.

invertebrate, central and peripheral nerve tissue and in muscle. The role of the acetylcholine system in elementary processes is pictured in Fig. 14. In the resting condition, acetylcholine is in a bound and inactive form. (S) Excitation of the membrane, by current or other stimulus, leads to a dissociation of the complex, and acetylcholine is released. The free ester acts upon a receptor protein (R), and this action upon the receptor is essential for the change of ionic permeability, i. e., for the increased Na conductance and thus of a generation of bioelectric potentials. Acetylcholine may act by changing the configuration of the receptor protein.

The complex between acetylcholine and the receptor is in a dynamic equilibrium with the free ester and the receptor. The free ester is susceptible to attack by acetylcholinesterase (E). The enzymatic hydrolysis of acetylcholine will permit the receptor to return to its resting condition. Sodium conductance returns to its original level. Thus, the action of the enzyme leads to immediate recovery and ends the cycle of the elementary process. The high speed of the inactivation process makes possible rapid restoration of the membrane and permits the nerve to respond to the next stimulus in a millisecond or less. The further recovery leads to the re-synthesis of acetylcholine in its bound form by choline acetylase and the other components of the acetylating system. The evidence supports the view that acetylcholine is the "specific operating substance" in the elementary process of conduction of nerve impulse, as Meyerhoff⁽¹¹⁾ applied it to the role of ATP in muscular contraction.

During the past twenty years, much pertinent information has been obtained by the analysis of the molecular forces acting in the proteins of the acetylcholine system. In several instances, it was possible to establish relationships between the reactions of the protein solution and the function

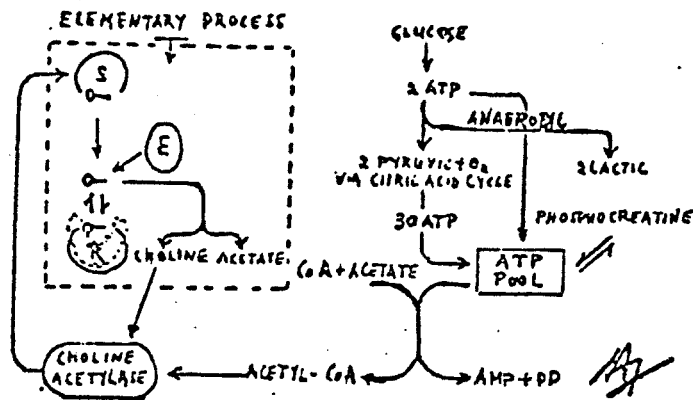

Fig. 14. Sequence of energy transformation associated with conduction and integration of the acetylcholine system into the metabolic pathways. (Redrawn after Nachmansohn⁽¹⁰⁾.)

S = bound acetylcholine

R = receptor protein

of the intact cell. In some cases, such relationships were found to parallel those of specific electrical events. A molecule such as acetylcholine has only a limited number of possibilities of reacting with a protein; the molecular forces acting between the small molecule and the macromolecules of the system must, therefore, be similar. Relatively small modifications in the surface of the protein may lead to important changes in function. Information obtained by the analysis of molecular forces in one protein will, therefore, provide valuable information for an understanding of the reactions with other proteins. Acetylcholinesterase is for many reasons the most suitable protein of the system for studying the molecular forces in the active surface.

Analysis of the molecular forces acting in the active surface of the enzyme has revealed that the surface has two functionally and spatially separated subsites: an "anionic" site and an "esteratic" site. The anionic site attracts the cationic groups of the substrate by Coulombic and Van der Waal's forces. The esteratic site has an acidic and a basic or nucleophilic group symbolized by H and G. The nucleophilic group forms a covalent bond with the electrophilic carbon of the carbonyl group (see Fig. 15).

The alcohol is eliminated from the enzyme substrate complex by an electronic shift and as a result of the first phase, an acetylated enzyme is formed. This reacts with H_2O to form acetate, thus regenerating the enzyme. Experimental evidence in support of this mechanism is mentioned by Nachmansohn.⁽¹⁰⁾

Determination of the biochemical composition of fish has been made by early investigators mostly on marine fish and the data has not been derived from a statistical meaningful number. Vinogradov⁽¹²⁾ points out that of the approximately 20,000 known species of fish, only 350 to 400 of

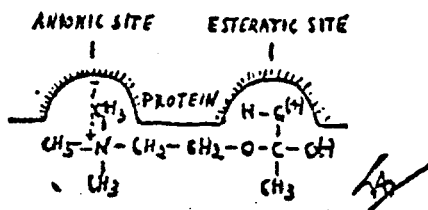

Fig. 15. Schematic presentation of the interaction of the active groups in the surface of acetylcholinesterase and the substrate. (The Michaelis-Menten complex; redrawn after Nachmansohn⁽¹⁰⁾.)

of them have been submitted to chemical analysis and the choice of species has usually been limited to those of commercial importance. Many analyses have been done on fish "as purchased" i. e., after being caught commercially and stored in ice for several days. The composition can alter considerably under such conditions, either from chemical or bacterial action, or by leaching out of constituents by the melting ice. Detailed analyses, as those of Suyama and Tokuhira⁽¹³⁾ on many organs of fish, are rare.

Complete analyses of the biochemical composition of electric fishes have not been made. Hasson and Chagas⁽¹⁴⁾ analyzed the interaction "in vitro" of macromolecules (proteins, polysaccharides, nucleic acids) with curare. Chromatographic analyses show the correlation between uronic acid concentration and TRIEG (gallanine triethyliodide) binding. Also the analysis of a hydrochloric acid hydrolysate gave glucose as the only reducing sugar component of Sf₁ (neutral polysaccharide). The Sf₃ (acid polysaccharide) dissolved in the acetate buffer being analyzed showed that glucuronic acid was the uronic acid constituent of Sf₃. Also acetylglucosamine, choline esterase and orcinol have been identified. In general they described the quantitative results of the interaction of quaternary ammonium bases, viz. acetylcholine, succinylcholine and TRIEG (gallanine triethyliodide) with non dialyzable components of the aqueous extract of the electric organ of Electrophorus electricus.

Fahn, Albers and Coval⁽¹⁵⁾ investigated the catalyses of the hydrolysis of adenosine triphosphate (ATP) in the presence of Mg⁺⁺, Na⁺, and K⁺ by the microsomal fraction from the electric organ of the electric eel, Electrophorus electricus. The same preparation catalyses a Mg⁺⁺-dependent transphosphorylation between ATP and ADP (adenosine diphosphate). Both of these reactions are inhibited after treatment of the microsomes with N-ethyl maleimide. However, the addition of Na⁺ reactivates the transphosphorylation, and the rate becomes more rapid than that of the original. This

new Na^+ -sensitive exchange reaction is believed to be a component of the hydrolytic reaction. J. P. Changeux et al.⁽¹⁶⁾ studied the asymmetric re-partition of AChE (acetylcholinesterase) of each of the two facets of the electroplate. They utilized acetylthiocholine as a substrate and isolated the AChE by ultracentrifugation. Cytochemical analysis of AChE has been done and electronmicrographs have been used in their study. Gautron⁽¹⁷⁾ verified a similar study on the electric organ of the Torpedo.

2.1.5 Physiology of the Electric Organs

The general physiology of the electric organs describing their common properties does not differ to much from other electrogenic tissues like nerves or muscles. The nervous or muscular activity is accompanied by transitory electrical variations called "action potentials." Some analogies can be made between the electroplate electric activity and the electric activity of nerves or muscles. Theories which apply to the cellular bioelectrogenesis are also applicable to electric discharge of the electric organs. Since the electric discharge is a physical phenomena it could be related to the structures where it is produced or where it manifests its effects. Two characteristics of electric organs should be taken into account: the electric conductivity and the electromotive force (EMF) of the electroplates. The electroplates EMF does not exceed 0.15 volts. Fessard⁽¹⁸⁾ calculated for the Torpedo marmorata the internal resistance to be between 7.3 ohms and 24.1 ohms. He found the total EMF of the electric organ to be 64 volts; the short circuit current 8.2 A. This data indicates that 400 electroplates are required in series to achieve this EMF. The data cited above apply to the electric organ during discharge. During rest the resistance is much higher. The electric discharge is accompanied by an increase in conductivity (or decrease in resistance). The specific resistances at rest of the electroplates of Torpedo and Electrophorus is shown in Table 1.⁽¹⁹⁾

TABLE 1

Specific Resistance of 1 Centimeter Cube of Electric Tissue
 Measured with the Aid of Nonpolarizable Electrodes
 (Ag-AgCl) with a DC or an AC Current of Less
 than 100 Hz. Electric Organ was in a Resting State.⁽¹⁹⁾

	resistivity in ohms cm ² /cm	
	Transversal	Lateral
<u>Torpedo</u> small size	1404	206
<u>Torpedo</u> medium size	760	260
<u>Electrophorus</u> main organ	318	106
<u>Electrophorus</u> organ of Sachs	146	105

The innervated posterior face of the electroplate of the organ of Sachs in Electrophorus electricus has a resistivity of 10 ohms/cm² at rest. The anterior face of the source electroplate has a resistance of 0.23 ohms/cm² (Keynes and Martins-Ferreira⁽¹⁹⁾).

The resting and action potentials of the electric eel, the Torpedo sp. and Raja sp. are shown in Table 2 and compared with the resting and action potential of the muscular striate fiber of the frog. A schematic of the electric charges on the surface of an electroplate is shown in Fig. 16. In resting position the charges are equal, opposite and neutralize each other. In the active state, the posterior innervated face is subjected to an inversion and the two EMF are added in series. The action potential seems to be produced by an increase in ionic permeability of the innervated face of the electroplate.

TABLE 2

Average Values of the EMF of Resting and Active Electroplates of Different Electric Fishes and Frog Muscle

Electroplates of:	Resting Potential mV	Action Potential mV	Reference
<u>Electrophorus</u> O. of Sachs	73-86	126-150	19, 20
<u>Electrophorus</u> main organ	70	127	19
<u>Torpedo</u>	(45)-70	115	21
<u>Raja</u>	65	60	22
Muscular striate fiber of the frog	90	125	23

The transverse electric resistance and DC potentials of the skin of Torpedo marmorata have been measured by Radil-Weiss and Kovacevic. ⁽²⁴⁾ Their results are summarized in Table 3 and the method is illustrated in Fig. 17. The skin samples were taken from areas either covering the electric organ or from adjacent non-electrical regions. No significant differences were found between the dorsal or ventral sides of the body. Body size has no influence on the resistance value, but the electrical resistance of the skin covering the electric organ is lower than from other parts of the body. DC potential measurements show that the external surface of the skin is slightly electropositive relative to the internal one.

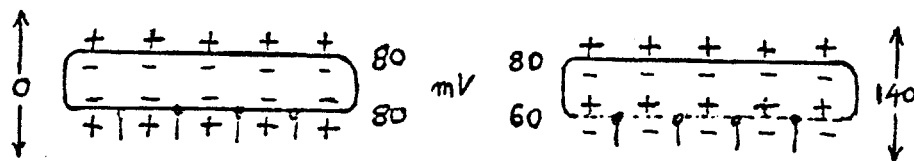

Fig. 16. Electric charge distribution on the electroplate.
 Left: resting state. Right: active state at
 maximum discharge.

TABLE 3

Impedance and DC Potential of Skin Samples of the Electric Fish Torpedo marmorata *

Type of skin sample tested	Skin impedance (Ω/cm^2)			Significance	DC potential (mV)	Significance
	surface +	surface -	average			
Dorsal electric			25.3 \pm 4.0 n = 13	} NS		
Ventral electric			37.6 \pm 9.4 n = 9			
Dorsal + ventral electric	31.3 \pm 4.6 n = 22	29.0 \pm 4.2 n = 22	35.4 \pm 4.4 n = 22	} NS	} 5%	} 1%
Dorsal non-electric			91.2 \pm 15.3 n = 11			
Ventral non-electric			143.8 \pm 47.9 n = 7	} NS	} 1%	} NS
Dorsal + ventral non-electric	109.8 \pm 17.1 n = 18	113.5 \pm 21.5 n = 18	111.6 \pm 20.2 n = 18			
Significances	NS					

All values expressed as average \pm S.E. of the mean, n = number of measurements. Significance computed by Student t test. NS non-significant.

* From Radel-Weiss and Kovacevic(24).

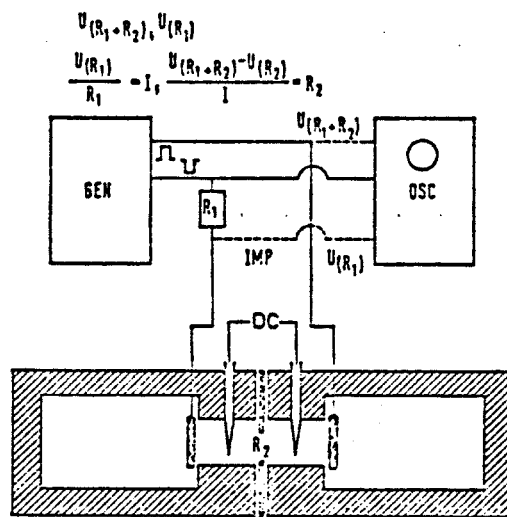

Fig. 17. Schematic representation of the impedance measuring apparatus. GEN Generator, OSC Tektronix oscilloscope, R_1 known resistance, R_2 resistance of skin sample.⁽²⁴⁾

Grundfest and Bennet⁽²⁵⁾ examined the physiology of the marine electric fishes: Astroscopus, Torpedo, Narcine and Raja (Raja clavata, Raja ocellata and Raja erinacea). They examined innervation, excitability and some pharmacological properties of these marine electric fish electroplates. The Torpedo electroplates did not respond to electrical simulation but did to chemical stimulation.⁽²⁵⁾ The electric organ of Electrophorus electricus has two excitable systems; one direct and one indirect.⁽²⁷⁻³⁰⁾ The electroplate of the main electric organ continues to respond to directly applied electric currents after it fails to respond to indirect, electrochemical neural stimuli.

Keynes et al.⁽³¹⁾ studied the morphology and electrophysiology of the electric organ of Malapterurus electricus, the African fresh-water electric catfish. Malapterurus is an exception to the Pauni's law, according to which the innervated faces of the electroplates become negative during discharge, whatever the anatomical orientation of the organ. This law holds for all other electric fishes. Until Johnels⁽³²⁾ studied the electric catfish and found out that their electric organ developed from myoblasts, the general consensus was that it had a glandular origin.

Bennett and Grundfest⁽³³⁾ also investigated the morphology and electrophysiology in Mormyridae which family includes 11 genera and probably several hundred species. They used only a few species: Mormyrus rume, Gnathonemus compressirostris, Gnathonemus petersii, Gnathonemus moori and Gnathonemus tamadua. The variety in form and signs of the pulses indicate structural and functional properties of the electroplates peculiar to the different forms. The electric organ discharges are composed of potentials contributed by the stalks that emerge from the caudal surface of each electroplate as well as of the responses of both major faces. The

stalks and both major surfaces are electrically excitable and generate spikes. The normally evoked discharges of the electroplates originate by synaptic excitation of the stalk, to which the innervation is applied at one locus in Gnathonemus or at a number of loci in Mormyrus rume. The stalk system serve to distribute excitation to the electroplate body so that the whole surface of the latter discharges nearly synchronously.

It is important to mention something about the thermal events during and after the discharge of strong electric fishes. We measured, in our previous investigations, the electric output of electric eels and electric catfishes. One of the electric eels (6 ft length) could discharge bursts of impulses of over 80 watts peak power and one of the electric catfishes could discharge over 30 watts peak power. Obviously some of the energy was dissipated in heat. Aubert, Fessard and Keynes⁽³⁴⁾ studied the thermal events accompanying the electric discharges of the electric eel and the Torpedo. They could distinguish three phases: the phase Q_1 following immediately after the electric discharge, marked by a rapid rise in temperature, followed by phase Q_2 marked by a slow decreasing phase which resulted in a temperature below its initial level. The phase Q_3 starts with a slow temperature rise and staying there for a few minutes at its highest level before returning to its initial temperature level. This latest phase Q_3 is conditioned by the external load and the amount of stimulation. It is also subject to fatigue and is highly ambient temperature-dependent.

There are some difficulties in interpreting the heat measurements in the case of the heat production during the electric discharge of the electric organ. Bernstein and Tschermak⁽³⁵⁾ estimated the specific heat for the whole organ of Torpedo to be 0.86 cal per g per °C. If it is accepted that for a full grown Torpedo nobiliana the electric organs could

weigh a few hundred kilograms, there is an appreciable amount of calories dissipated. For example: for every hundred kilograms of electric organ, 86,000 calories would be dissipated per °C. Some major ambiguities exist such as the nonthermal Q_1 phase of Electrophorus, which is followed by the cooling Q_2 phase and the slow heating phase Q_3 . The Joule effect and heat propagation have not been studied, and there is a possible interference of these factors with the results of the estimated specific heat for the electric organ.

The activity of the electric organ and its discharges are cephalically controlled. The electroplates are in a parallel series and are well synchronized and delays assure a fast rising time of the impulse. Albe-Fessard and Martins-Ferreira⁽³⁶⁾ investigated the role of the nervous command system in the functional synchronization of the electroplates of Electrophorus electricus.

The electric organ is controlled by a nucleus of cells in the medulla, activated by a synchronous volley from a still unidentified higher level in the brain.

It seems that the frequency of discharge of the electric signal of electric fishes is a quantifiable behavioral variable.

2.2 ELECTRORECEPTORS AND ELECTRORECEPTION

Some marine and fresh water fishes are sensitive to weak electric currents or slight changes or discontinuities in an electromagnetic field. Most species having this property are also electric fish, but since the term of electric fish is reserved for species which produce electric discharges there are some nonelectric fishes which have electroreceptors but no electric transmitting organs. The fresh water catfishes Kryptopterus ameiurus nebulosus and clarias and many sharks like the dogfish Scyliorhinus canicula and the lemon shark Negaprion brevirostris have electroreceptors.

Only electric fishes having a complex array of different kinds of electroreceptors can discriminate the different stimuli affecting the electromagnetic field surrounding the fish (generated or not by its own electric organ). (4, 3 -39, 40-44) Electroreceptors are part of the "lateralis line" system in fish. The electrosensory system of fish can be active, passive or both, depending on whether the fish have or does not have an electric transmitting organ and if the electroreceptors are or are not autorhythmic.

The electrosensory systems have extraordinary sensitivities: thresholds of $0.01 \mu\text{V/cm}$ have been reported in behavior experiments. (4, 45, 46)

Electroreceptors are located along most of the body. Usually electroreceptors are more numerous on the head than on the rest of the body. Electroreceptors can be classified by their physiological or behavioral characteristics. We have mentioned previously that from the physiological viewpoint electroreceptors can be classified as:

- a. Synchronous,
- b. Non-synchronous;

or:

- c. Phasic (not to be confused with phase indicators),
- d. Tonic;

or:

- e. Ampullary type
- f. Tuberous type.

From the behavioral viewpoint the electroreceptors can be classified as indicating:

- a. Movement
- b. Direction
- c. Conductivity
- d. Acceleration
- e. Phase of an electric signal
- f. Frequency of an electric signal, and
- g. Amplitude of an electric signal.

2.2.1 Distribution of the Electrosensory Receptors

The electroreceptors sensory fields of Gnathonemus petersii^(18, 19) can be clearly visualized if we put the fish in a solution of 10% buffered formaline. Figures 20 and 21 show the limits of these sensory fields.

There are between 700 and 1000 tuberous organ electroreceptors, between 800 and 1000 type A mormyromasts electroreceptors and between 2100 and 2300 type B mormyromasts electroreceptors in the skin of an adult Gnathonemus petersii.⁽⁴⁷⁾ The total number of electroreceptors varies between 3600 and 4300. These are distributed on the body as follows: between 42 to 46% on the head on 41 to 44% of the electroreceptor fields; between 30 and 32% on the dorsal sides on 27 to 30% of the electroreceptor fields; and between 22 and 26% on the ventral sides on 25 to 32% of the electroreceptor fields. The total area of the electroreceptor fields may occupy between 2000 and 5000 mm² area for fishes between 90 and 125 mm length. Figure 22 shows the different types of mormyromast electroreceptors of Gnathonemus petersii.

With the exception of the sensory receptors of the chin which are mechanical displacement receptors and are connected to the CNS through

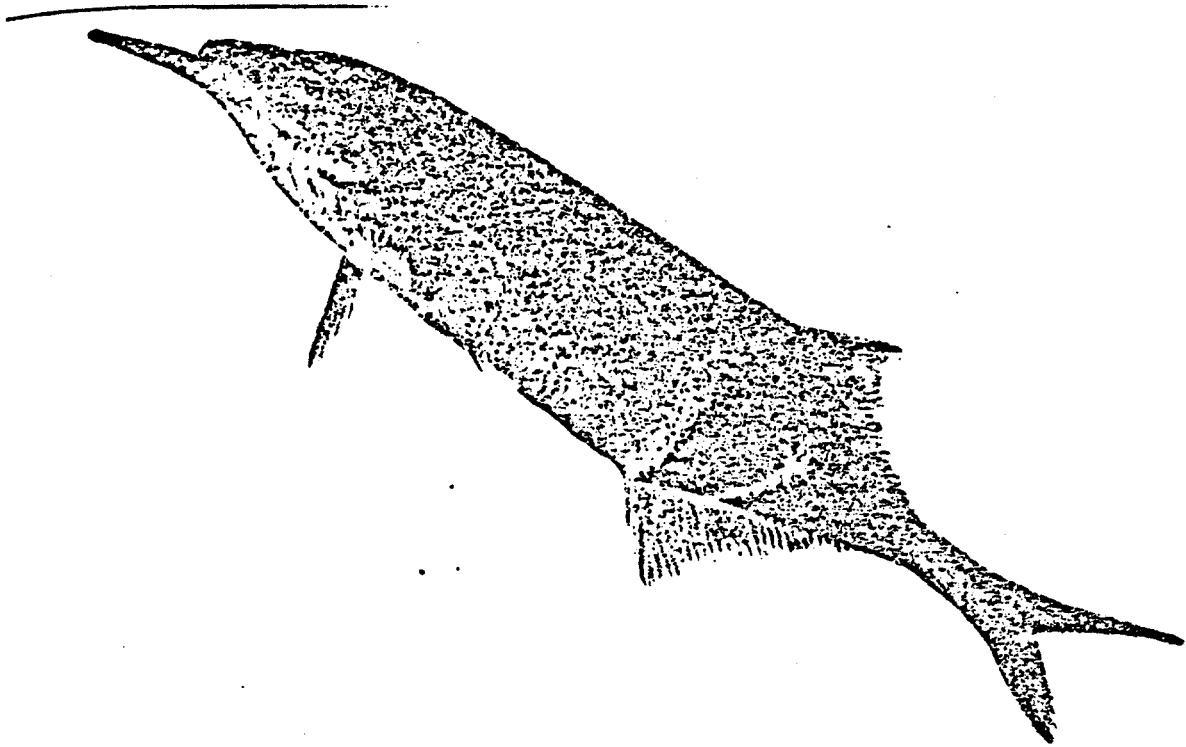

Fig. 18. African fresh water weakly electric fish Gnathonemus petersii.

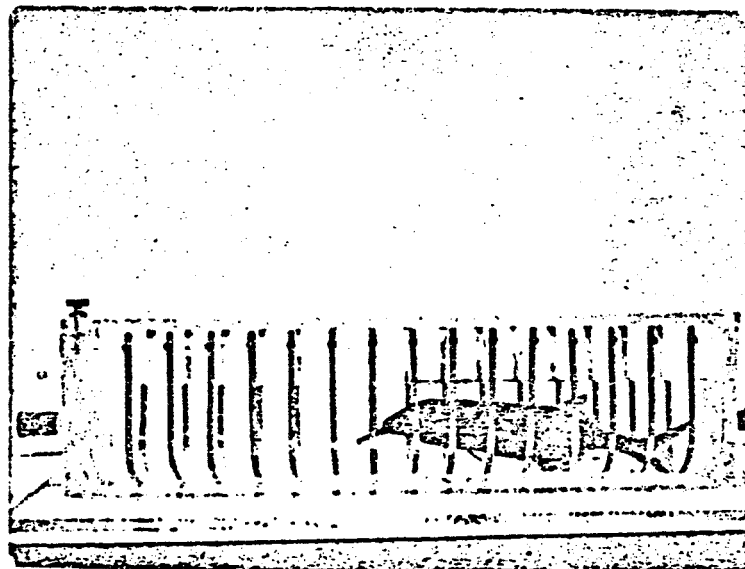

Fig. 19. Electric fish Gnathonemus petersii in a lucite restraining tray provided with stainless steel electrodes.

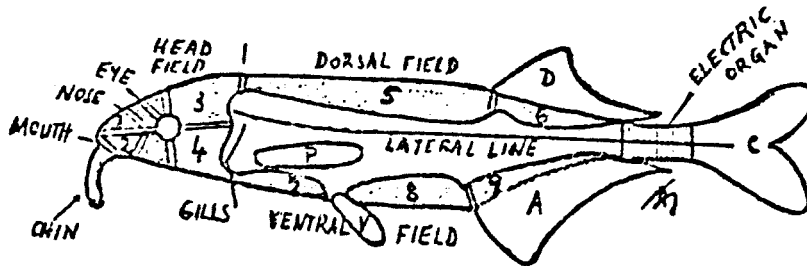

Fig. 20. The electric sensory fields of Gnathonemus petersii.

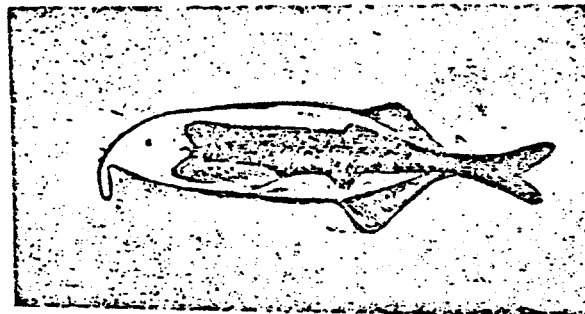

Fig. 21. Limits of the electroreceptors sensory fields of Gnathonemus petersii.

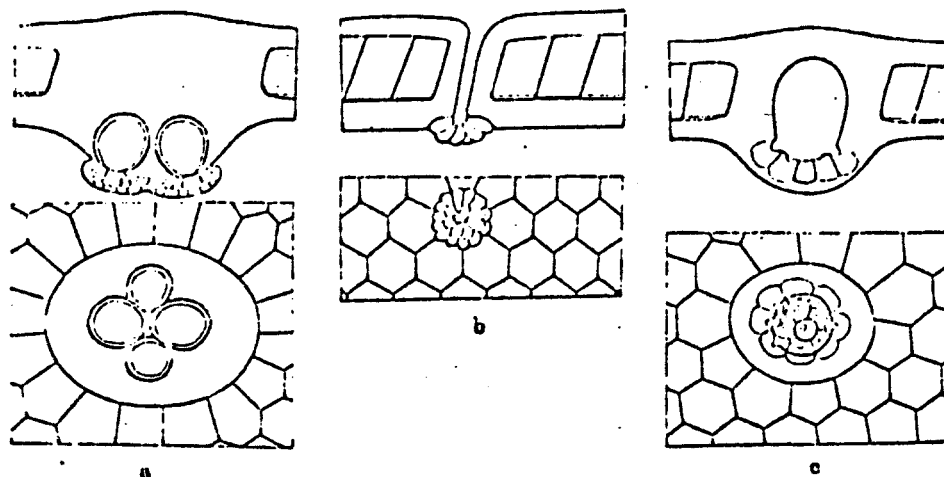

Fig. 22. Different types of mormyromasts:
 a. tuberos organ
 b. A-mormyromast
 c. B-mormyromast
 (top and cut view).

the nervus trigeminus, the mormyromast electroreceptors are subserved by the lateral line nerves. Figure 23 shows the main branches of the lateralis nervous system. All the mormyromasts types (tuberous, A and B) are connected to nerves forming bundles pertaining to the lateral line system and ending in the brain. Figure 24 shows an electronmicrograph of a mormyromast type II.

The tuberous organ electroreceptors are autorhythmic and the EMF may reach a few millivolts. The repetition rate varies from 550 to 3900 with the most often encountered repetition rate between 950 and 1950 Hz.

Figure 25 shows a comparison between sensitivity and density of the electroreceptors in the epidermis of Gnathonemus petersii and Fig. 26 shows the autorhythmic activity of the electroreceptors near the chin and near the eye.

2.2.2 Tonic and Phasic Electroreceptors

Figure 28, Fig. 31a and 33 b show ampullary tonic electroreceptors. They resemble to the Lorenzini ampulla, a multisensory receptor.⁽³⁷⁾ Dotterweich⁽⁴⁸⁾ mentioned twenty five morphologically different types of Lorenzini ampulla. It seems that depending on function and species of fish there is a large variation of this type of sensory receptor. One of the differentiating characteristics of the ampullary sensory receptors is the number of receptor cells which are embedded in the wall of the ampulla. Only a small part of their circumference is exposed to the lumen, although the surface in this region may be increased by microvilli.^(49, 50, 51, 52) They are innervated by single afferent fibers on their inner surface and are surrounded by supporting cells. The response of a tonic ampullary receptor is shown in Fig. 29. The ampullary electro-

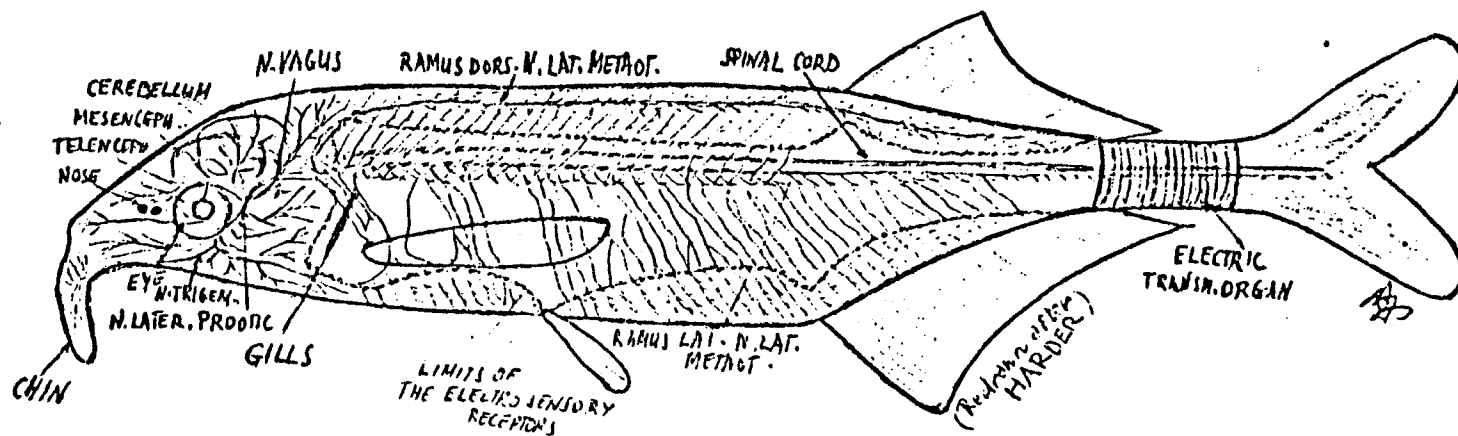

Fig. 23. The lateral line nerves of the electric fish Gnathonemus petersii.
(Redrawn after Harder(47).)

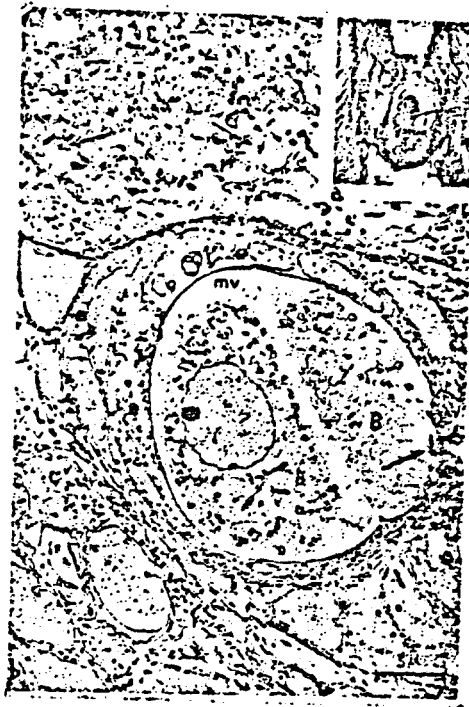

Fig. 24. Electromicrograph:

- a. Transverse cut of Gnathonemus epithelium: mormyromast type II with sensory cells A and B. Helly's fixative; staining: Azam
- b. Higher magnification of the A and B type cells. Arrows indicate synaptic zones; c: fibrous capsule; staining: phosphotungstic acid.

(after: Baretts and Szabo(49)).

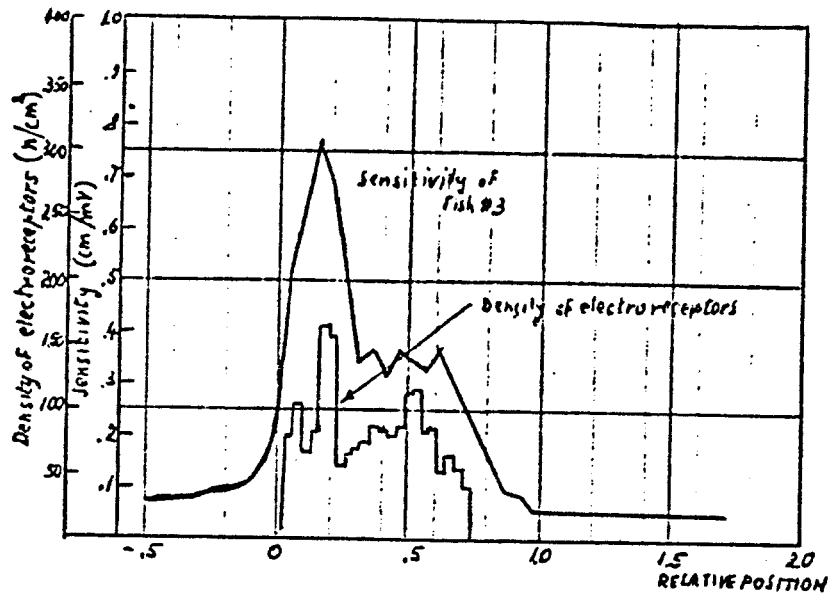

Fig. 25. Comparison between sensitivity and density of the electroreceptors of Gnathonemus petersii in the epidermis (after Harder (47)).

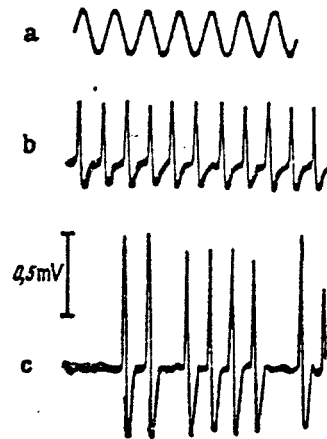

Fig. 26. Autorhythmic activity of the electroreceptors of Gnathonemus petersii:

- a. 500 Hz calibration signal
 - b. electroreceptors near the chin
 - c. electroreceptors near the eye
- (after Harder (47)).

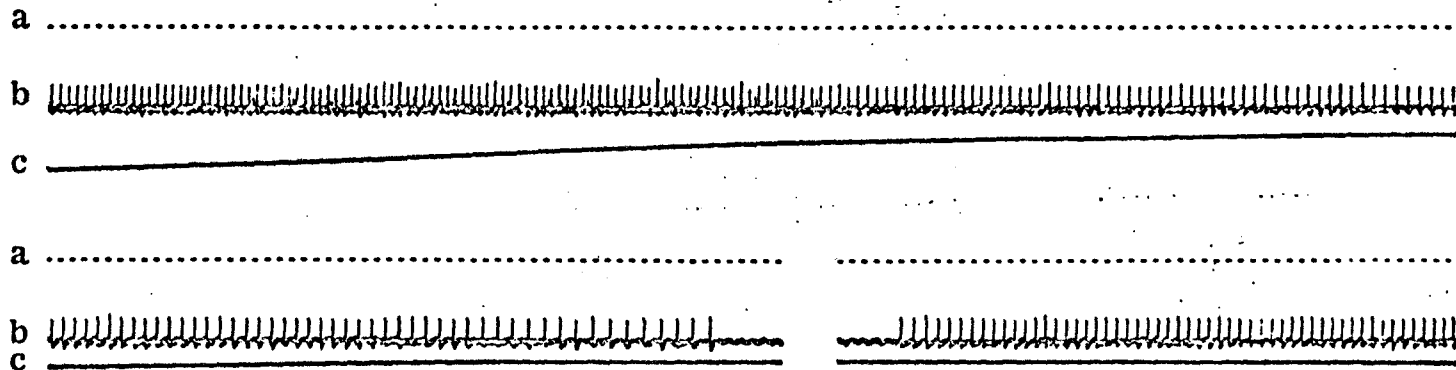

Fig. 27. Electric activity from the nervus lateral anterior innervating receptor near the proboscis of a mechanical displacement on the chin of *Gnathonemus petersii* when the proboscis has been moved upwards (after Harder (47)).

- a. time marks = 50 Hz
- b. electric activity in the nerve
- c. movement of the chin proboscis

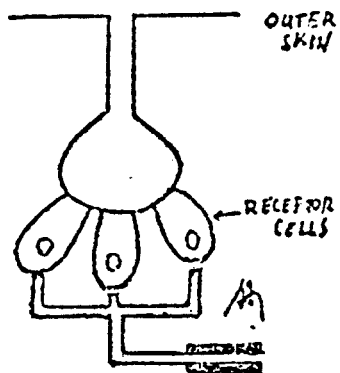

Fig. 28. Ampullary tonic electroreceptor. (Schematic)

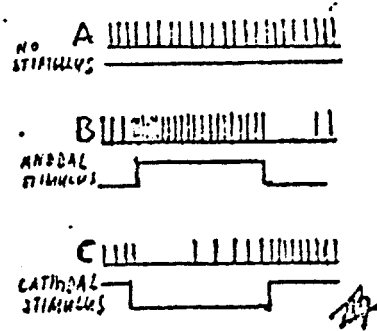

Fig. 29. Stimulus and recording from an ampullary tonic electroreceptor.

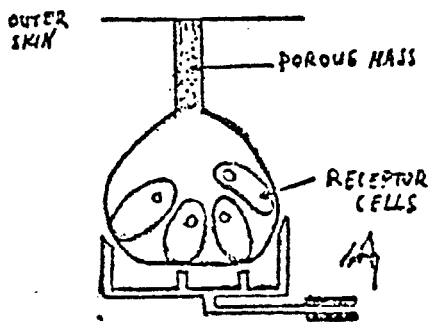

Fig. 30. Tuberous phasic electroreceptor. (Schematic)

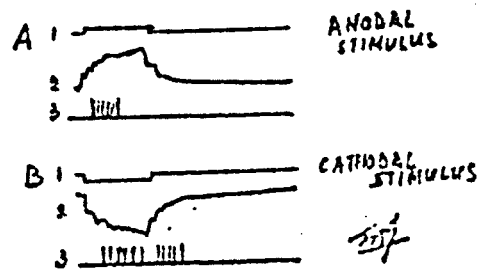

Fig. 31. Stimulus and recording from a tuberous phasic electroreceptor.

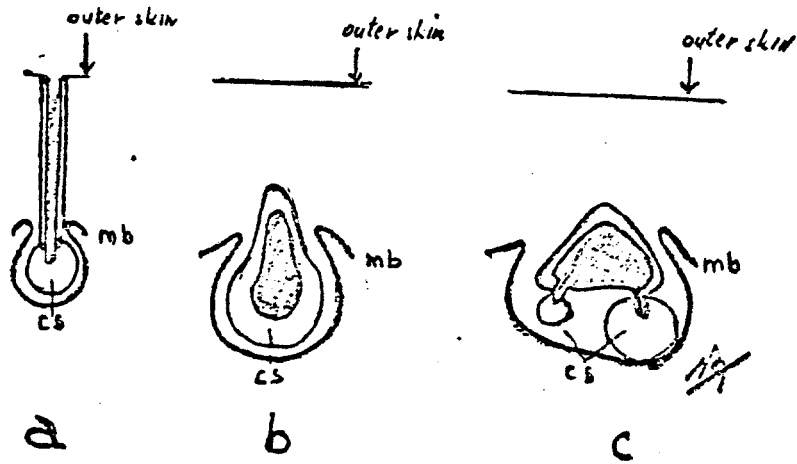
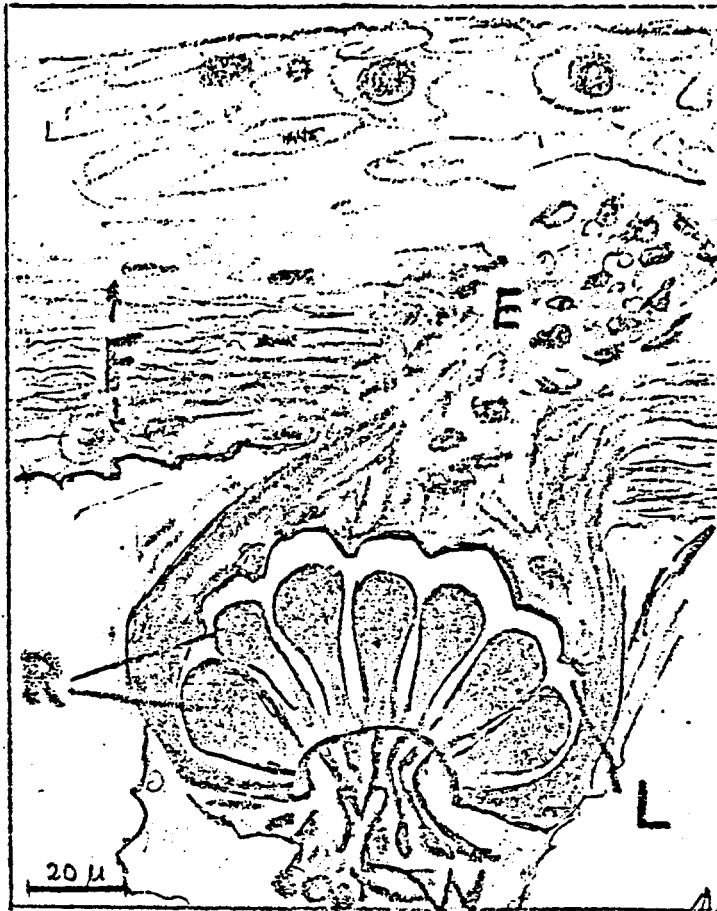

Fig. 32. Electroreceptors of Gymnarchus niloticus.

- a: ampullary electroreceptor b: tuberous electroreceptor type b
 c: tuberous electroreceptor type c. (Schematic)



R = RECEPTOR CELLS N = NERVE FIBER
 E = EPITHELIAL TISSUE L = LUMEN
 F = FLATTENED CELLS

Fig. 33. Phasic electroreceptor, South American fresh water weak electric fish (after Szamier and Wachtel⁽⁵¹⁾).

of a tonic ampullary receptor is shown in Fig. 29. The ampullary electroreceptors are connected to the exterior by an obvious canal filled with a polymucosaccharide jelly. There is evidence that different kinds of ampullary sensory receptors (electroreceptors, mechanoreceptors, temperature receptors) may have biochemically different jellies in the canals. (46)

Anatomically and functionally the phasic electroreceptors are different from the tonic receptors. No obvious canal connects the lumen of the phasic electroreceptors to the exterior. A plug of loosely packed epithelial cells are interposed between the receptor and the superficial layer of the epidermis. Phasic electroreceptors are shown in Figs. 24, 30, 32b and c, 33, 34c, d and e, and 35. Phasic electroreceptors are sensitive to higher frequency stimuli than the tonic types. The phasic electroreceptors behave as if a capacitor was interposed between the cell proper and the exterior of the fish. Three properties derived from the fact that there is a capacitance between the cell and the exterior can be ascribed to the phasic electroreceptors: (1) equivalence of onset and termination of long-lasting stimuli of opposite polarity; (2) absence of excitability change during maintained stimuli; and (3) absence of net current flow during externally recorded responses. (53)

2.2.3 The Control and Function of the Electroreceptors

We mentioned that the electroreceptors are part of the lateral line system in fish. The functional characteristics of six different kinds of lateral line organs have been considered: canal neuromasts, free neuromasts, ampullary electroreceptors, ampullary displacement receptors, mormyromasts and bulbar organs. Some of the organs are autoactive, others are only activated by the electric discharges of the transmitting organ. From the six different lateral line organs mentioned, three types are electric and three

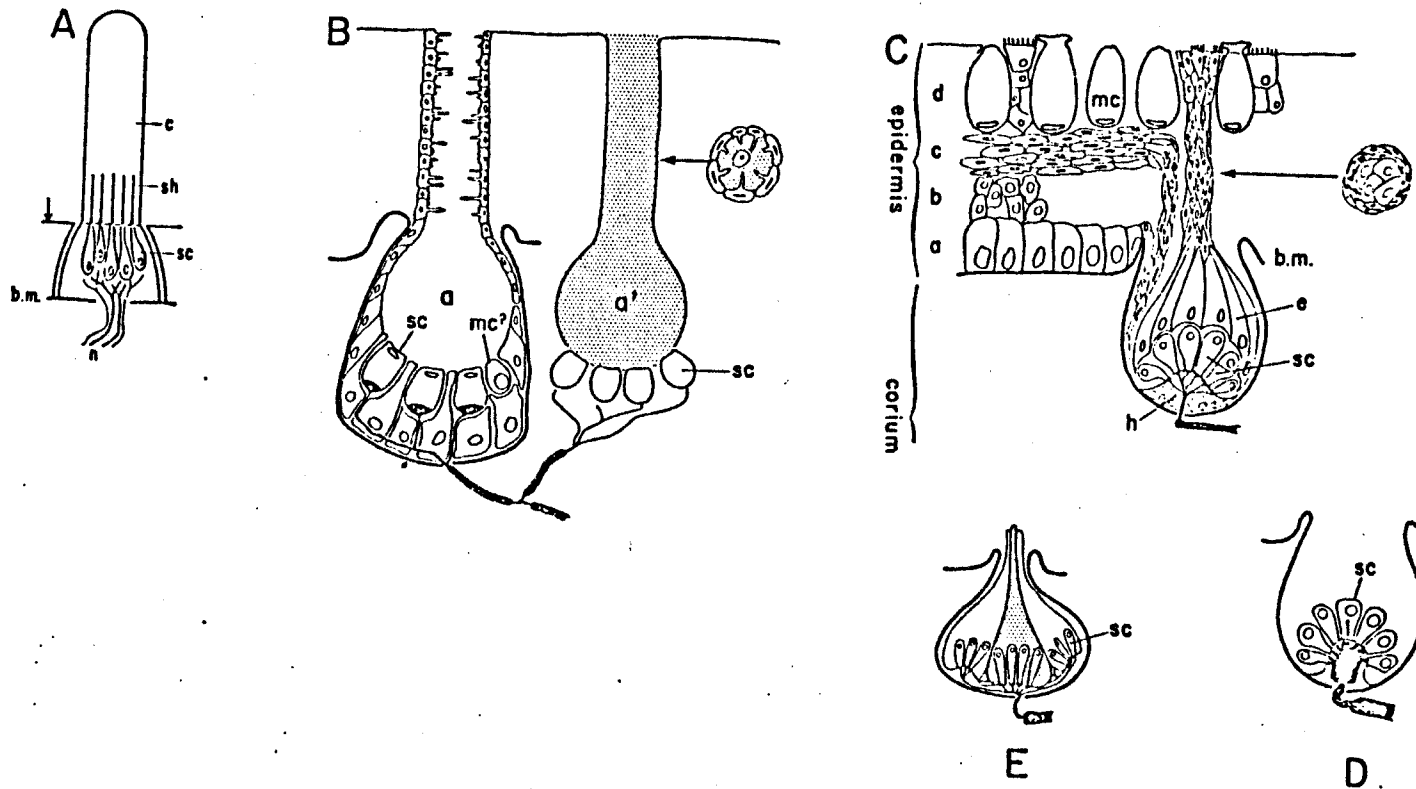

Fig. 34. Schematic drawings of ordinary and specialized lateral line organs of gymnotids (after Th. Szabo).

- A. Schematic drawing of "ordinary" lateral-line organ.
- B. Organ type I (ampullary organ).
- C. Organ type IIA (tuberos organ) (Hypopomus).
- D. Another type (IIB) of tuberos organ (Hypopomus).
- E. Tuberos organ type IIC (Electrophorus).

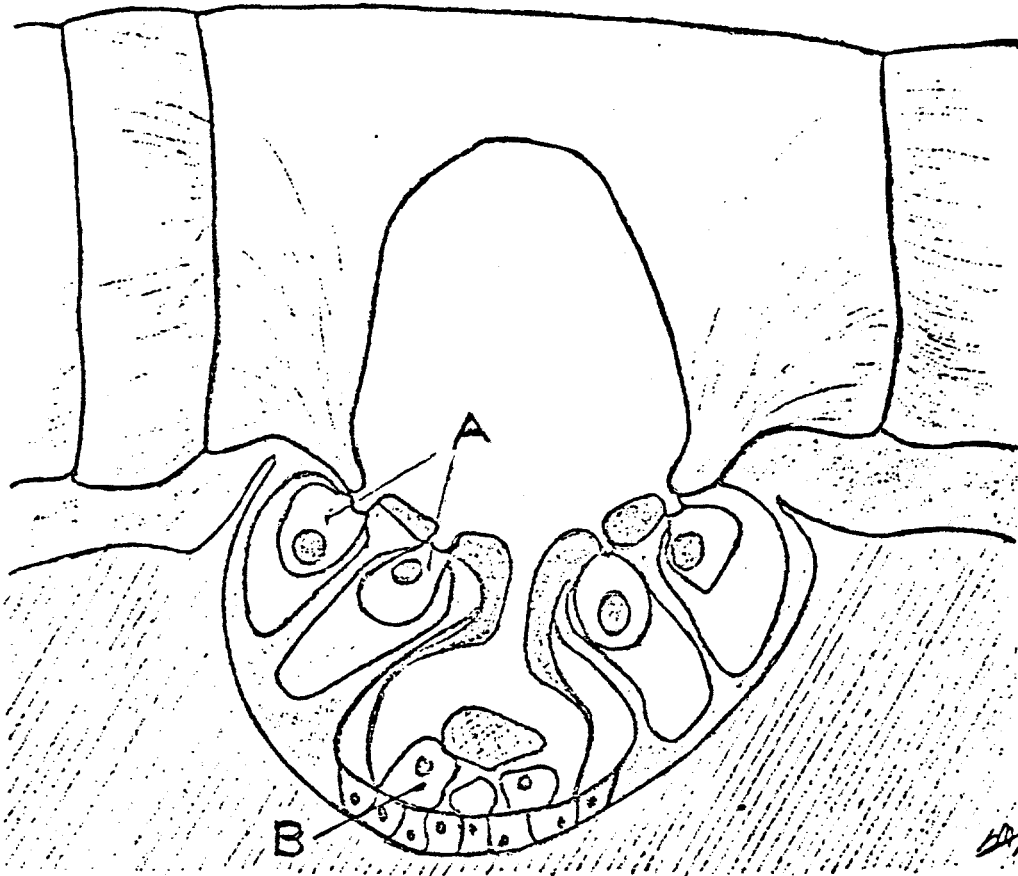

Fig. 35. Tuberos organ (electroreceptor) of Gnathonemus petersii.

types are mechanical receptors. It seems that the fish utilize the electrical receptors for communication and object recognition and the mechanical receptors for swimming and for proximity feeding.

There is a correlation between the electrical and the mechanical stimuli and a differentiation at the higher nervous levels. The investigation of the roles of the different receptors in mormyrids for object detection, location and identification, may help to elucidate their function.

Hagiwara, Szabo and Enger⁽⁵⁴⁾ studied the effect of local conductivity of the external environment of the electric fish Sternarchus albifrons on its electroreceptors. They found that the information about the local conductivity is transmitted through the sensory nerve fibers innervating the electroreceptors to the higher nervous centers. Sternarchus albifrons has a high frequency electric organ discharge (650-1000 Hz). "The impulse frequency of the electroreceptor nerve fiber increases when the control edge of a metal plate (conductive object) or the control edge of a plastic plate (nonconductive object) is above the receptor of the fiber."⁽⁵⁴⁾ (Fig. 36)

Both phasic and tonic electroreceptor response is determined first by the rate of change of the current intensity and second by the intensity of the current. Movement of the object affects the phasic electroreceptors. If a constant-voltage pulse field is applied between the head and the tail of the fish the increasing or decreasing of the signal rate in the nerve fiber of the electroreceptor is conditioned by the polarity of the stimulus. Synchronization of the electroreceptor nerve fiber frequency and the frequency of the electric organ of Sternarchus albifrons exists only at a high intensity of the field potential.

Szabo and Fessard⁽³⁹⁾ investigated the electroreceptors in mormyrids and Belbenoit⁽⁵⁵⁾ studied the ability to locate objects by similar fish species.

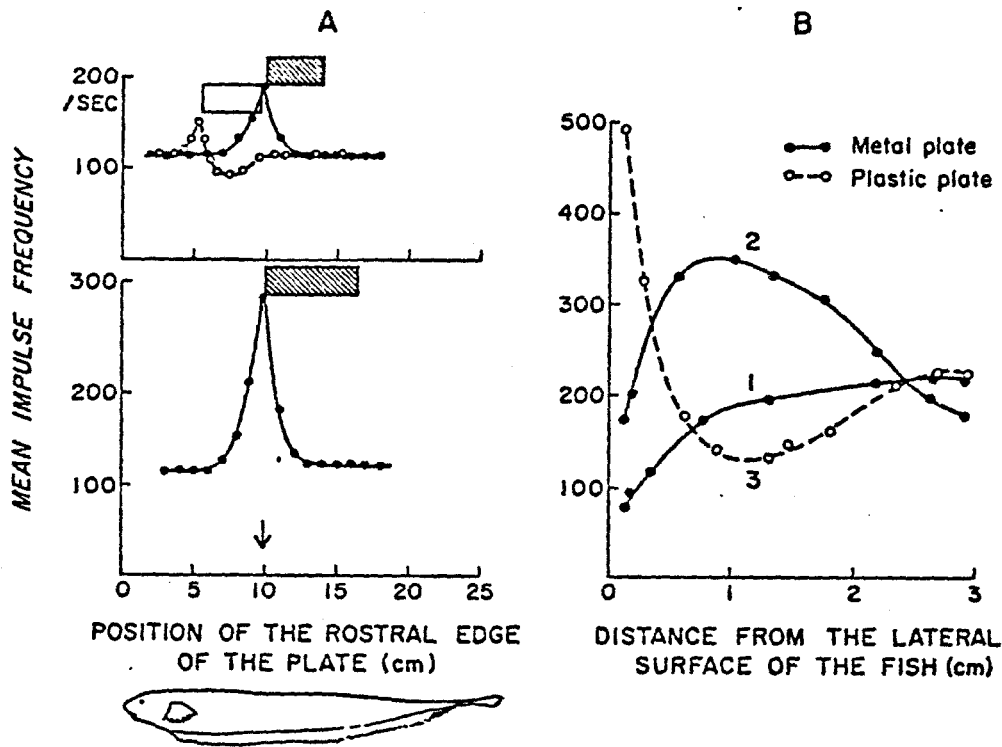

Fig. 36. A: relationship between the steady-state nerve impulse frequency and the position of the plate along the long axis of the fish; upper diagram for (4x2 cm) metal (dots) and plastic (circles) plates, lower diagram for a (6x2 cm) metal plate. Arrow indicates location of receptor. B: relationship between nerve impulse frequency and distance between plate and lateral surface of the fish. Curves 1, 2, 3, were obtained with three different positions of the plate along the long axis of the fish. (After Hagiwara, Szabo and Enger)

They found that some electroreceptors have a continuous autorhythmic activity which could surpass 2000 Hz. This activity could be modulated by an alternating current present in the aquarium. These electroreceptors are similar to the Franz⁽⁵⁶⁾ "tuberous organs." They concluded that the electroreceptive function consists in encoding peripheral signals by variations in frequency, phase and latency of the electroreceptor units and by changing the number and distribution of the activated or inactivated receptors. A pacemaker seems to control the autorhythmic activity of the receptors.

The author has performed simultaneous recordings from the electric transmitting organ and from autorhythmic ampullary tonic electroreceptors of Sternarchus albifrons (see Figs. 37a and b). The transmitting organ was discharging at a rate of approximately 680 cycles/sec; the autorhythmic activity discharged at a rate of approximately 900 cycles/sec and an amplitude of about 2 mV.

2.2.4 Active Electroreception

Lissman and Machin⁽³⁹⁾ studied the behavior of Gymnarchus niloticus and concluded that the detection and location of objects by the fish is due to both the transmitting electric organ and the electroreceptor array. Any object that would come in the proximity of the fish would constitute a discontinuity in the electromagnetic field generated by the electric transmitting organ. This discontinuity would affect the electroreceptors. The information transmitted by these electroreceptors to the higher nervous centers would determine the behavior of the fish.

Lissman and Machin^(38, appendix) attempted to explain this phenomena. The authors suggested that the fish is integrating the second derivative of the

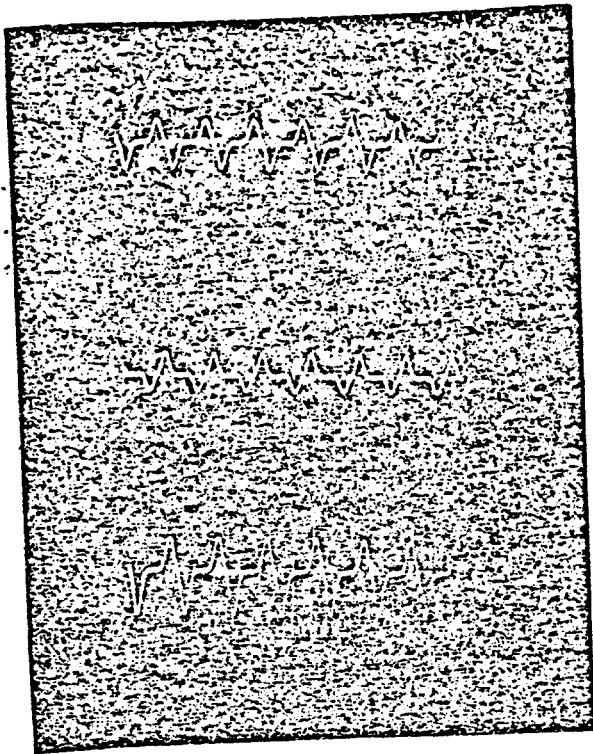
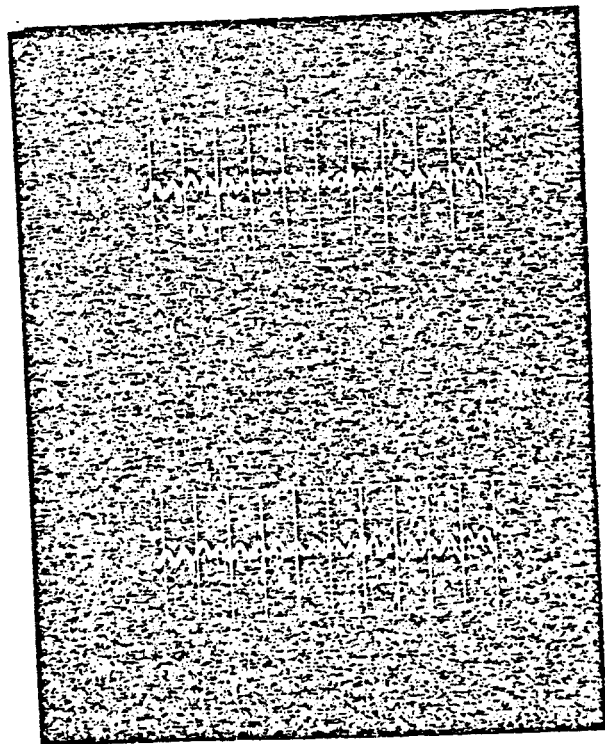

Figure 37a. Recording from an anaesthetized, curarized Sternarchus albifrons specimen. Horizontal: 1 graduation = 1 msec. Vertical: 1 graduation = 10 mV.

Figure 37b. Microelectrode recording of the autorhythmic electrical activity of the ampullary, tonic electroreceptors of Sternarchus albifrons. The spikes seen on the top of the rhythmic almost sinusoidal waveform are the electric signals from the electroreceptors. Horizontal: 1 graduation = 2 msec. Vertical: 1 graduation = 500 mV. Amplification x100, effective 1 graduation = 5 mV. Spike app. 2 to 2.5 mV.



the received signal and thereby increasing significantly the signal-to-noise ratio of the signal.

2.2.5 Passive Electroreception

Previous and actual investigations have shown that certain electric fishes cease transmission when objects which could represent a threat are brought in close proximity. The fishes continue to react to the presence of these objects even after their transmissions have ceased. This could indicate that they are still able to detect the presence of these objects by using their electromagnetic sensor array in a passive mode. There is evidence in the literature which tends to support this conclusion. For example, Bullock⁽⁵⁷⁾ recently mentioned that sharks, fresh-water catfish and electric fish use low or high frequency electroreceptors for passively detecting objects. Kalmijn⁽⁵⁸⁾ published an article on the electric sense of sharks which have no transmitting electric organ.

Szabo⁽⁵⁹⁾ denervated the transmitting electric organ of Gymnarchus niloticus and made it inactive. He recorded the autonomic activity of electroreceptors in the skin (3-12 mV) at a frequency of 310 to 340 Hz. The fish with the denervated transmitting electric organ will react normally to metallic objects brought close to it. This result suggests that the electric organ discharge may not be essential for the localization of objects in close proximity to the fish.

Szabo and Sakata⁽⁶⁰⁾ used curare to block the electric transmitting organ command-center in the brain and found that the mesencephalic potential depends on the impulses transmitted by the electroreceptor system of the fish, and not on the rhythmic activity of the transmitting organ.

Agalides⁽⁴⁶⁾ reported in 1963 to the ONR that lemon sharks, Negaprion brevirostris, have very sensitive electroreceptors, but no transmitting organ.

This evidence emphasizes the importance of the electrosensory array in the identification and location of objects. Under certain conditions, the fish may not need a transmitting organ in order to navigate, detect, locate and identify objects. On the other hand, it has been demonstrated that if the electrosensor array is incapacitated, the fish cannot navigate correctly or find food. ⁽⁶⁰⁾

2.2.6 Coding of the Electrical Signal of Electric Fishes

Investigators of electric fishes proposed different kinds of coding schemes for their electric signals. Lissman and Machin ⁽³⁸⁾ proposed a

1. "Pulse-frequency-modulation" (like in Gymnarchus niloticus);

Watanabe and Bullock ⁽⁶²⁾ proposed a

2. "Pulse-phase modulation" (like in Eigenmannia virescens);

Szabo and Hagiwara ⁽⁶¹⁾ analyzed and suggested three other kinds of codings:

3. "Number coding mechanism" (like in Hypopomus artedi),
4. "Probability coding mechanism" (like in Sternarchus albifrons),
5. "Latency coding mechanism" (like in Gnathonemus petersii).

According to the first hypothesis "Pulse-frequency modulation" sensory information should be conveyed by the frequency of the sensory impulses dependent on the pulse of the electric discharges.

The second hypothesis "Pulse-phase modulation" the sensory coding is the result of time relation (the phase) on the sensory impulse following the electric organ discharge.

The third hypothesis called the "Number coding mechanism" supposes that the intensity of the electric potential field is coded through a single electroreceptor fiber by the number of nerve impulses produced by each electric organ pulse.

In the number four hypothesis, called "Probability coding mechanism," the coding is provided by the probability that each electric organ impulse might initiate an impulse in the nerve fiber.

Finally the fifth hypothesis: "Latency coding mechanism" is explained by the fact that certain mormyrid electroreceptors permit a change in latency of the electric organ impulses related to the intensity of the current flowing through the receptor. Therefore, the intensity of the potential field can be coded by the time relation between electric transmitting organ discharge and sensory impulse, the time ranging being as much as 8 milliseconds. For variations in the superthreshold field intensity this would be the only mechanism for a sensory organ producing single spikes. The place where the latency-shift of the sensory impulse is taking place has not as yet unequivocally explained.

It is worth mentioning that there are electroreceptors connected to nerve fibers which would not transmit any impulses without a specific stimulus. Other electroreceptors are related to nerve fibers discharging continuously. Some, when presented with stimuli, increase their electric activity and others decrease it.

2.3 EXPERIMENTAL FINDINGS

2.3.1 Methods

Figures 38 and 39 show two African fresh water weakly electric fishes. Figures 40 and 42 show two South-American fresh water weakly electric fishes. Figure 41 shows an African fresh water strong electric fish and Fig. 42 shows a South American fresh water strong electric fish.

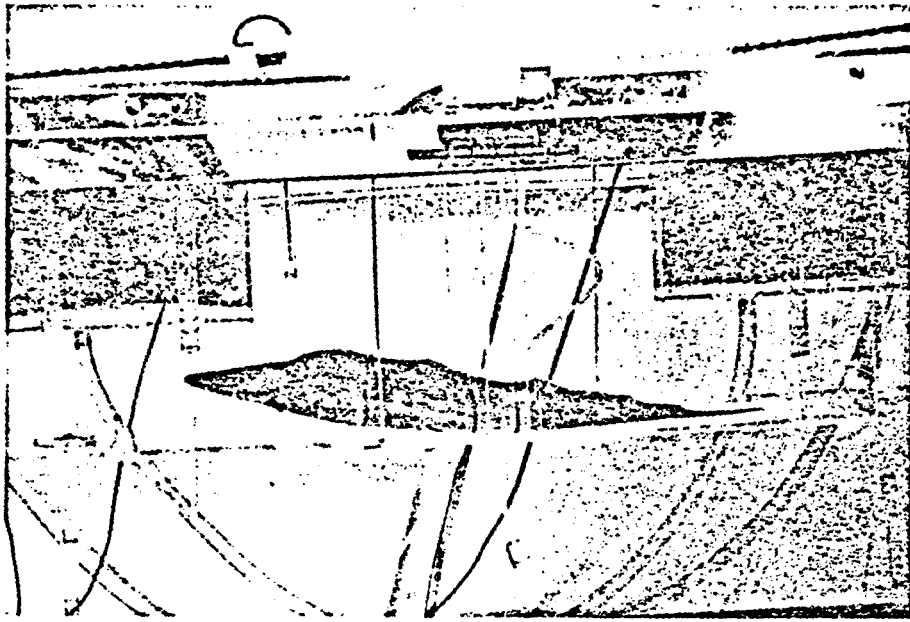

Fig. 38. Gymnarchus niloticus. African fresh water, weakly electric fish. 45 cm long, weight: 600 g, land of origin - Congo. Repetition rate of the signal: constant medium rate \approx 300 per second.

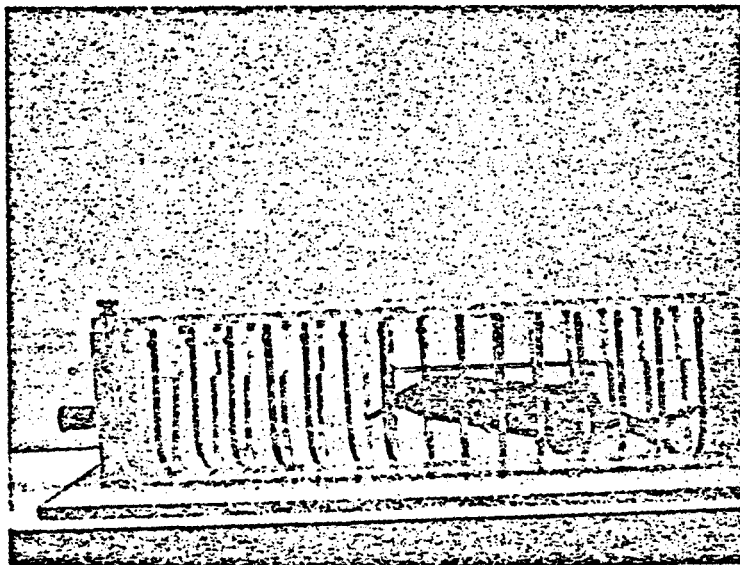

Fig. 39. Gnathonemus petersii. African fresh water, weakly electric fish. 15 cm long, weight: 19 g, land of origin - Nigeria. Repetition rate of the signal: variable low rate: 2 to 150 per second.

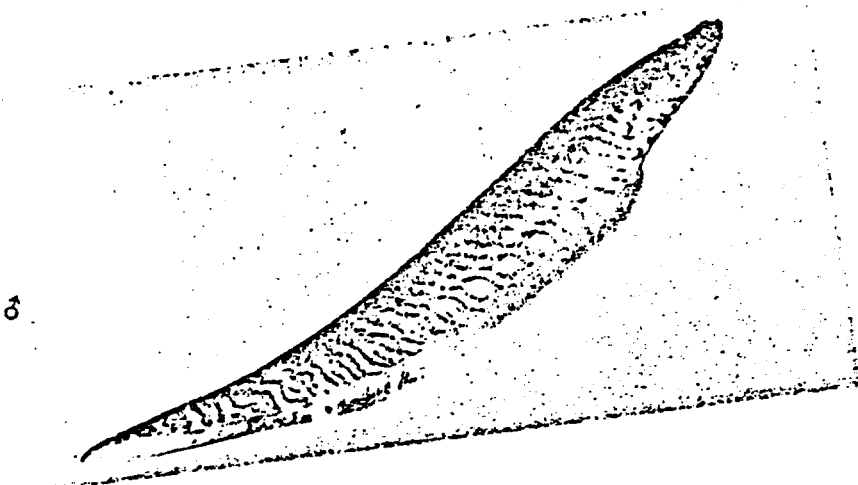

Fig. 40. Gymnotus carapo. South American fresh-water weakly electric fish, 22 cm long, weight: 180 g; land of origin - Brazil. Repetition rate of the signal: variable medium rate: 49 to 150 per sec.

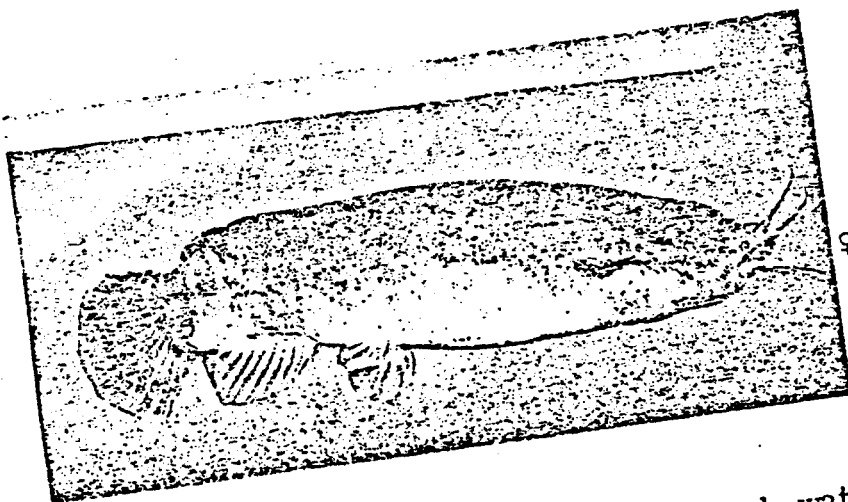

Fig. 41. Malapterurus electricus. African fresh-water strong electric fish, 18 cm long, weight: 215 g. Bursts of 7 to 15 pulses: 150 to 200 volts.

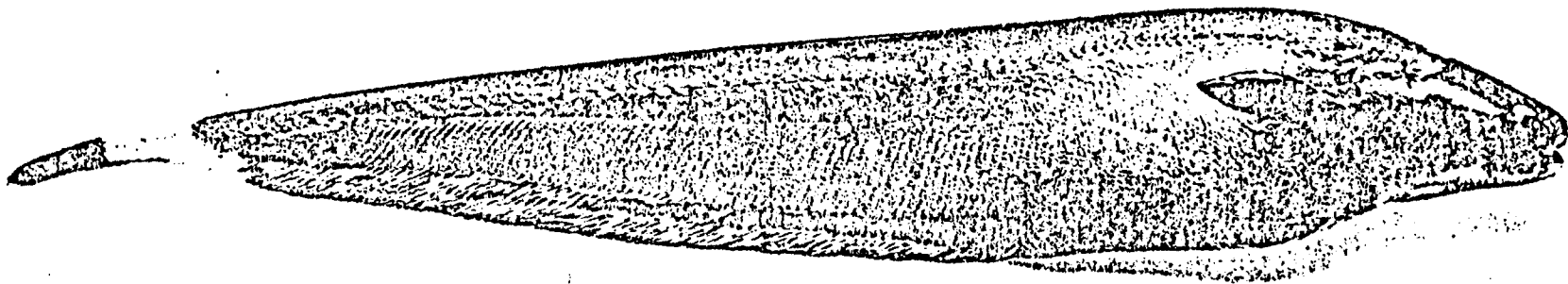

Fig. 42. Sternarchus albifrons. South American fresh water weakly electric fish, 17 cm long, weight: 32 g; land of origin - Brazil. Repetition rate of the signal which is constant with constant water temp.: 760 per sec at 23°C.

Figures 43 to 49 show the electric signal of five fresh water weakly electric fishes.

A corner of our laboratory with aquaria is shown in Fig. 50. In Fig. 51 different restraining cages for the fish is shown. In Fig. 52 a self-built microelectrode amplifier is shown and in Fig. 53 the instrumentation used for recording and playing back the electric fishes electric signals is shown.

2.3.2 The Electromagnetic Field Generated by *Sternarchus albifrons* A South American Fresh Water Weakly Electric Fish

The 12 foot diameter, 4 foot high fiberglass water tank filled with approximately 1000 gallons of fresh water of pH 7.1 has been used for the electromagnetic field measurements.

The water is heated by 2x1000 watt heaters controlled by a "YSI" to 0.1 °C temperature controller. The water in the tank is normally held at 25°C. The heaters are in a separate 30 gallon ("heater") tank and are connected to a relay switching them on and off and controlled by the temperature controller. Two 9 gallon per minute pumps circulate water from the large tank to the heater tank and return.

The silver-silver chloride-platinized-silver-chloride electrodes are attached to rails of nylon string, allowing them to be moved from one end to the other end of the tank. The electrodes are connected to a remote controlled differential amplifier (ampl. fact. x 4200) suspended over the tank and from the amplifier to the oscilloscopes Tektronix type 555, or type 502 with differential input.

An electric fish was suspended on one of the restraining devices shown in Fig. 70. The fish restraining devices were provided with stainless steel end-electrodes which were connected to an audioamplifier (ampl. fact. = 400)

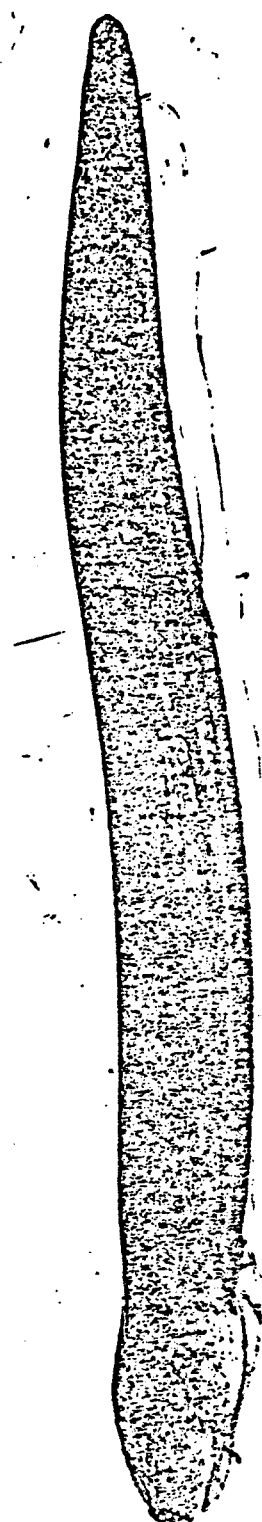

Fig. 43. Electrophorus electricus, South American fresh water strong electric fish. Has three electric organs: main organ discharge about 70-100 volts per foot length of the fish; organ of Hunter: 1-7 volts used for navigation; organ of Sachs: the purpose and discharge of this organ are not as yet well established.



Fig. 44. *Gnathonemus petersii* train of impulses $1/10$
 $\frac{\text{sec}}{\text{grad}}$ 0.5 V per grad .

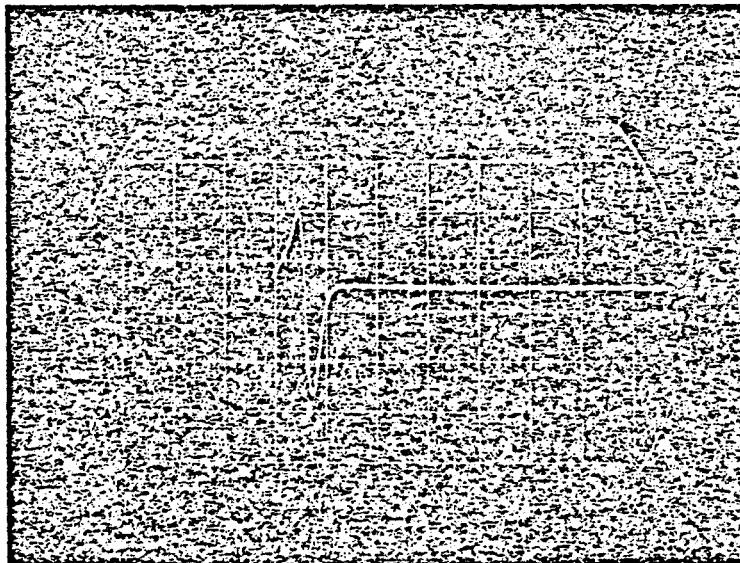

Fig. 45. *Gnathonemus petersii* single impulse 200 micro-
 $\frac{\text{seconds}}{\text{grad}}$ 1 volt grad .

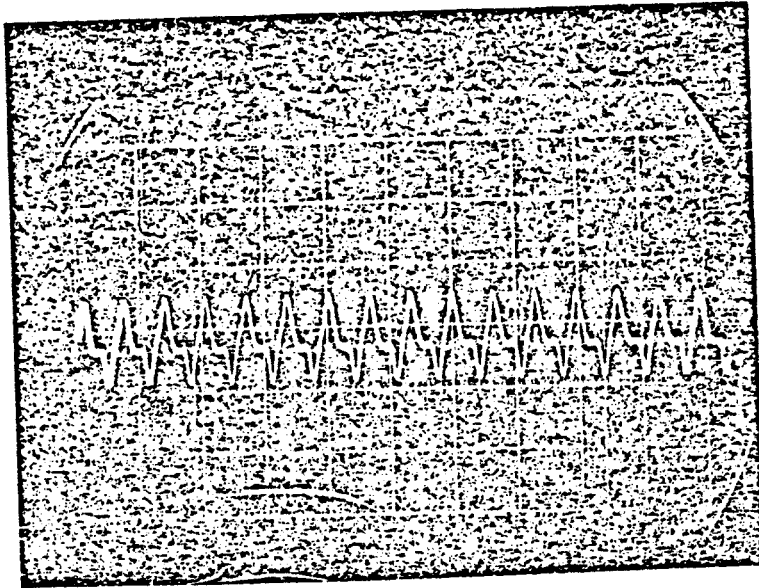

Fig. 46. Sternarchus albifrons electric signal, repetition rate: 760 per sec, water temperature: 23⁰C, amplitude: 10 mV grad, sweep = 0.5 msec grad, carbon electrodes 8 inches apart.

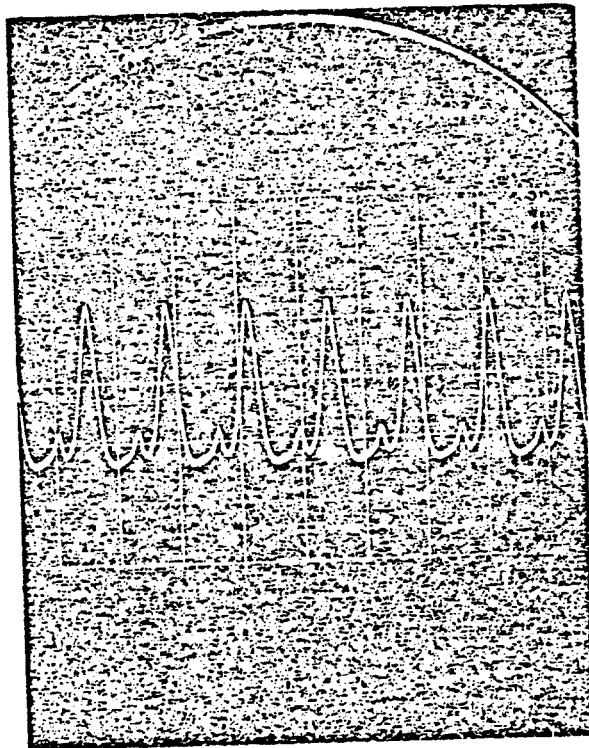

Fig. 47. Gymnarchus niloticus electric signal, repetition rate: 320 per sec, water temperature: 24⁰C, amplitude: 5 mV grad, sweep: 0.5 msec grad, carbon electrodes 12 inches apart.

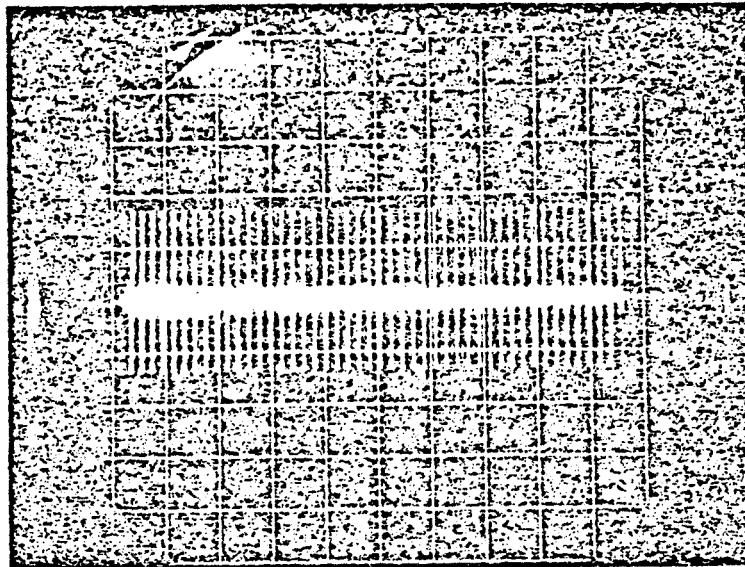

Fig. 48. Gymnotus carapo electric signal, repetition rate: 9.5 per sec, water temperature: 24°C, amplitude: 100 mV/grad, sweep: .5 sec/grad, special lucite tray with stainless steel electrodes.

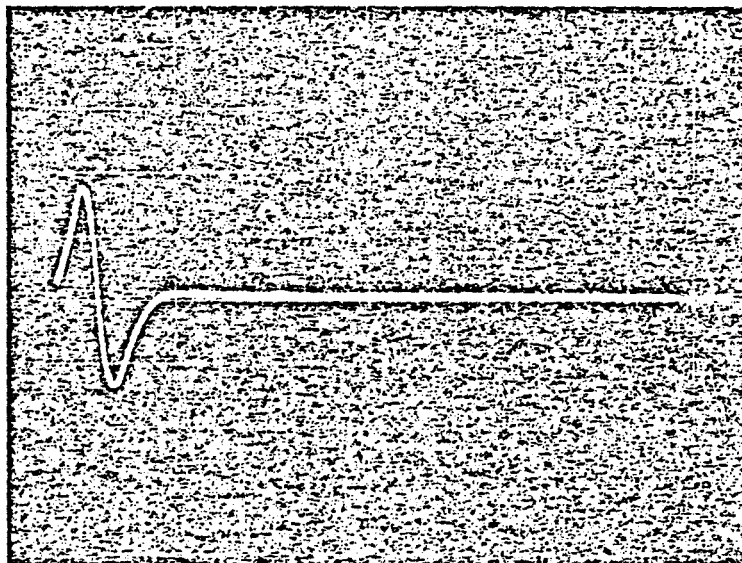

Fig. 49. Gymnotus carapo electric signal, single spike, amplitude: 100 mV/grad, sweep: 500 microsec/grad, special lucite tray with stainless steel electrodes.

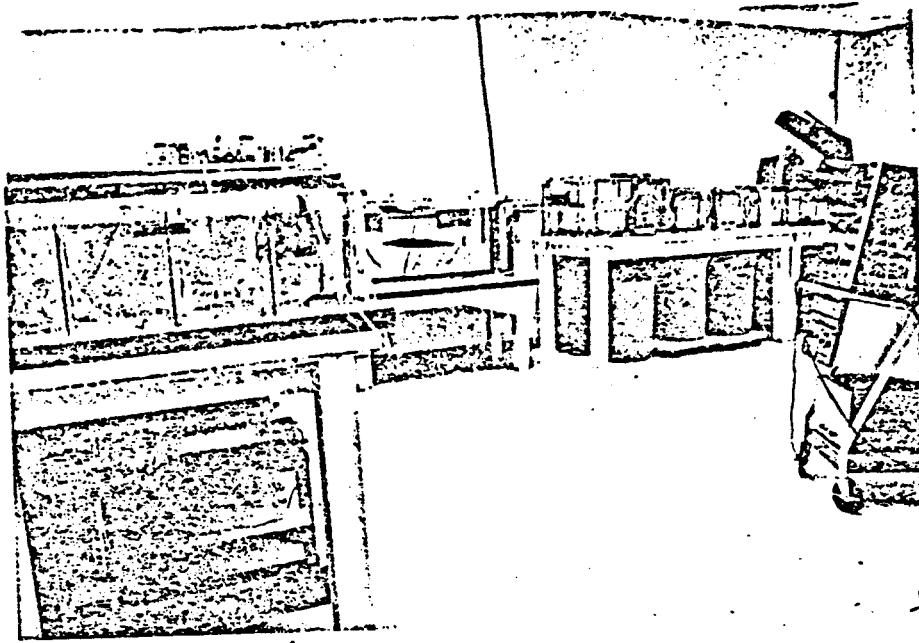

Fig. 50. View of a corner in the electrophysiology laboratory with the aquaria for electric fish.

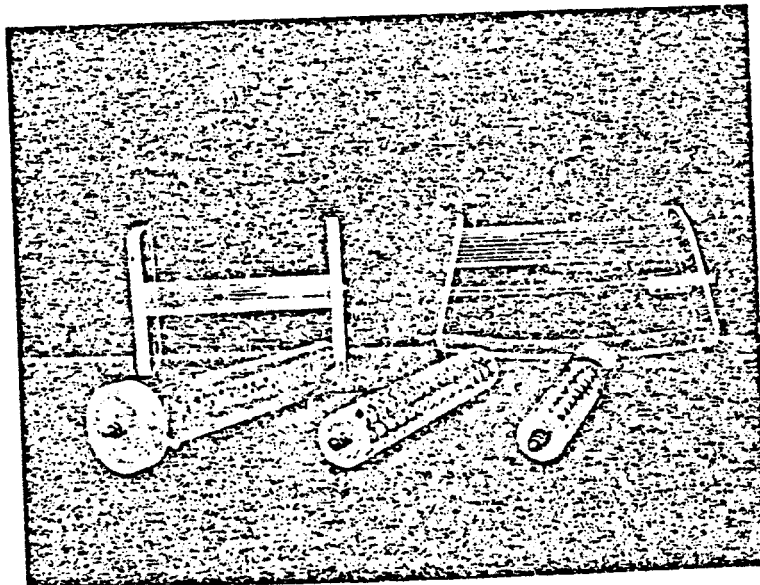

Fig. 51. Different kinds of lucite restraining cages for the fish.

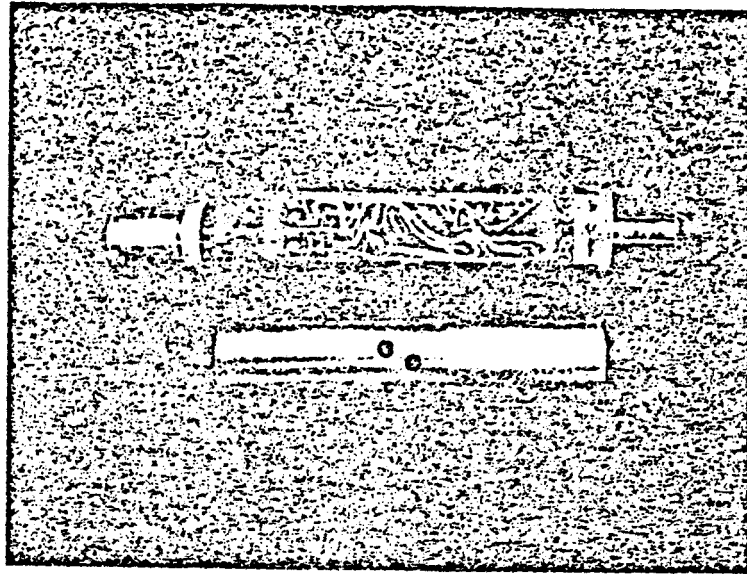

Fig. 52. Microelectrode support and amplifier. Bottom.

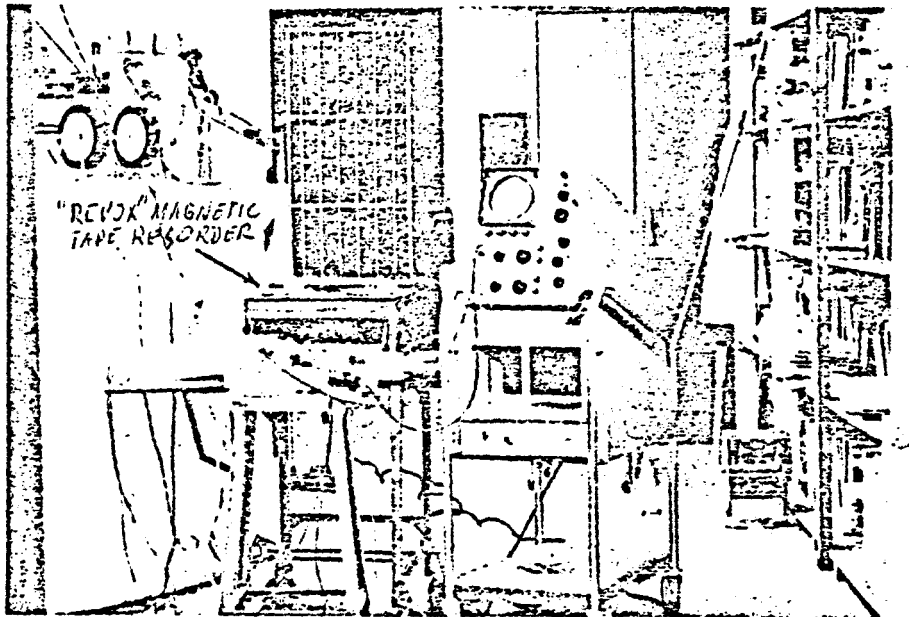

Fig. 53. Amplifiers, oscilloscope and Revox magnetic tape recorder with Dolbi-filter, for playing back the electrical activity of electric fishes recorded on magnetic tape.

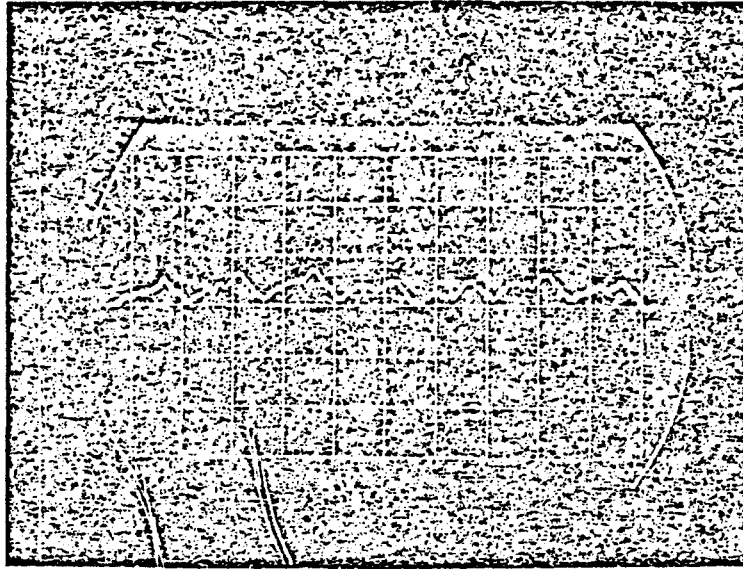

Fig. 54. Electrical activity of Sternarchus albifrons. Fish in lucite and nylon fish line fixture; the pick-up electrodes were parallel with the fish, distance: 40 cm, amplitude: 0.2 V/grad, fish at 0° , amplifier amplification factor: x 4200.

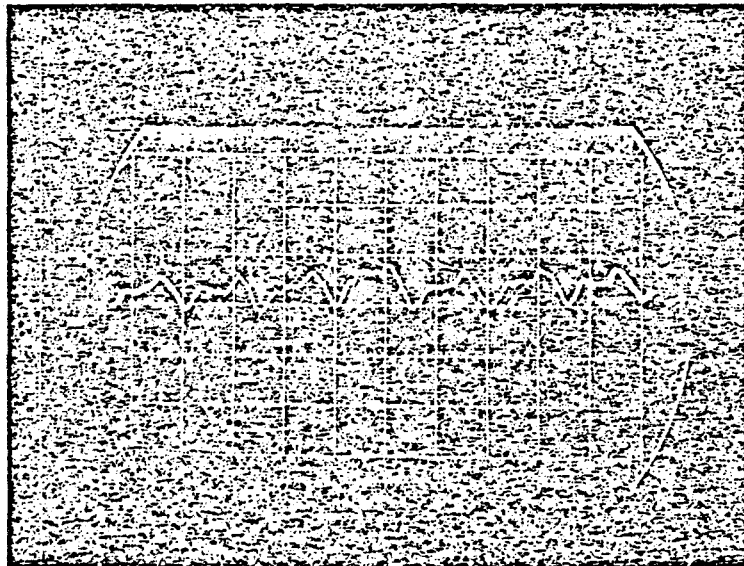

Fig. 55. Electrical activity of Sternarchus albifrons. Same as Fig. 54 but the pick-up electrodes were parallel with the fish, amplitude: 0.2 V/grad, fish at 22.5° .

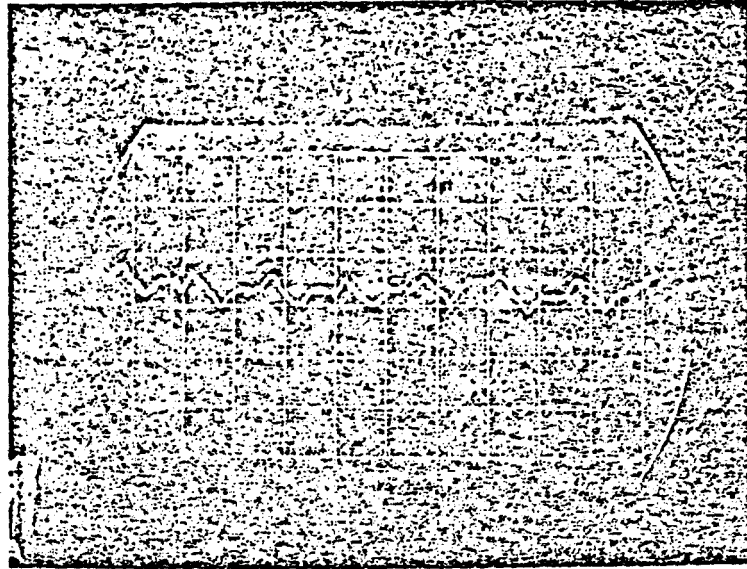

Fig. 56. Electrical activity of Sternarchus albifrons. Same as Fig. 54 but the pick-up electrodes were parallel with the fish, amplitude: 0.2 V/grad, fish at 45°.

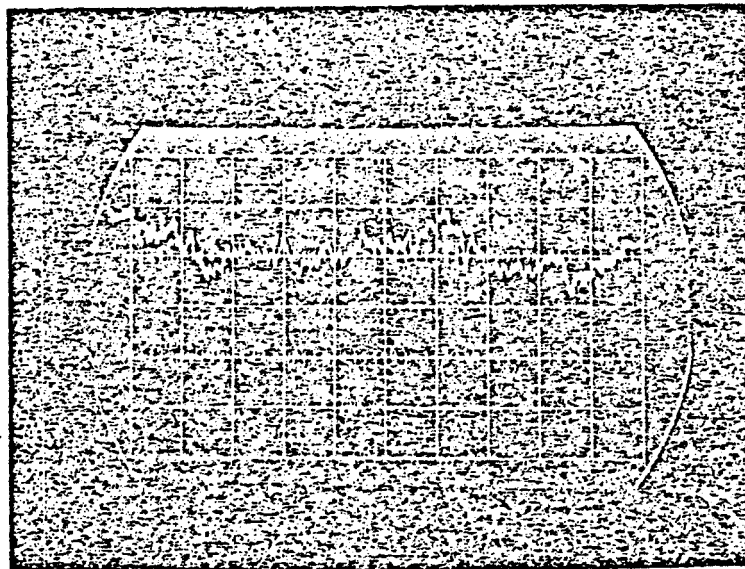

Fig. 57. Electrical activity of Sternarchus albifrons. Same as Fig. 54 but the pick-up electrodes were parallel with the fish, amplitude: 100 mV/grad, fish at 67.5°.

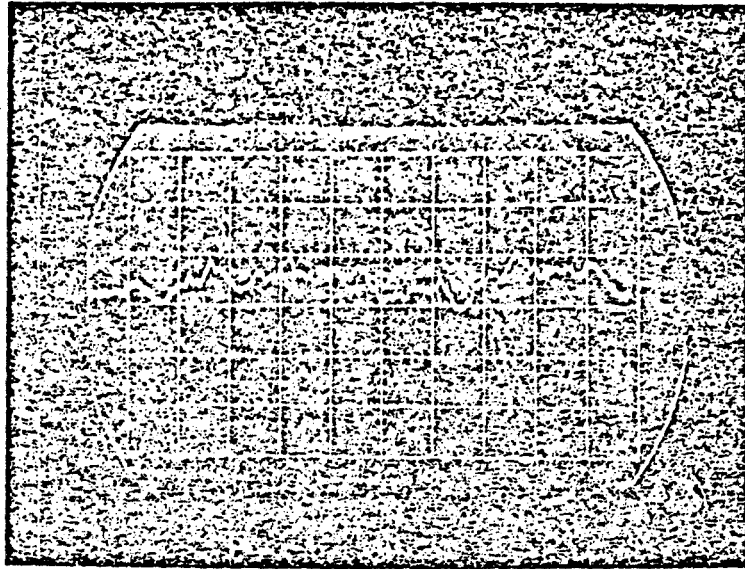

Fig. 58. Electrical activity of Sternarchus albifrons. Same as Fig. 54 but the pick-up electrodes were parallel with the fish, amplitude: 50 mV/grad, fish at 90° .

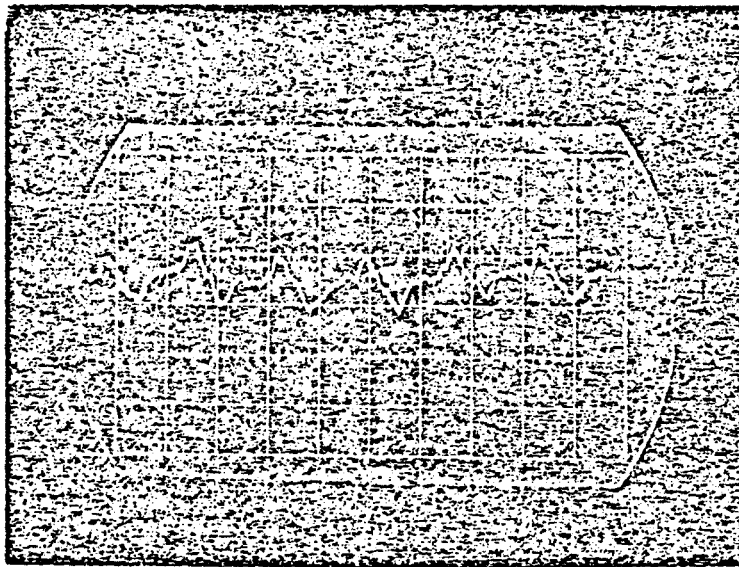

Fig. 59. Electrical activity of Sternarchus albifrons. Fish in lucite and nylon fish line fixture, pick-up electrodes perpendicular to the fish, distance: 40 cm, fish at 0° , amplitude: 100 mV/grad, sweep: 1 msec, amplifier amplification factor: x 4200.

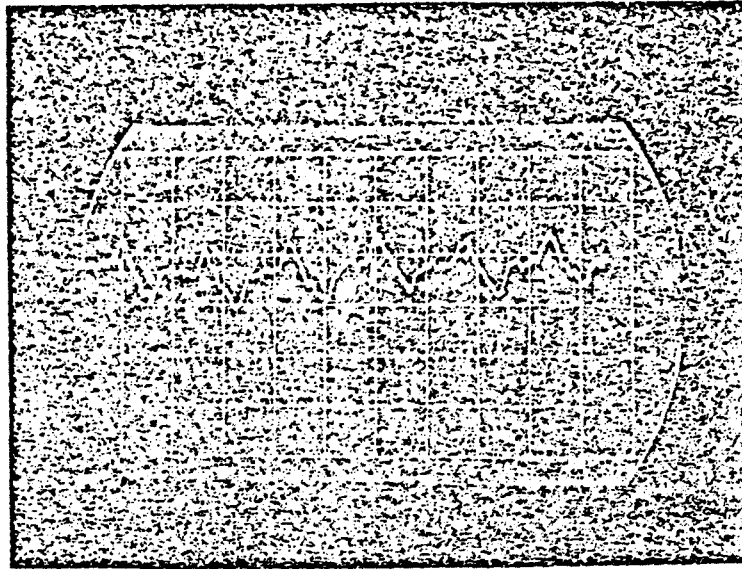

Fig. 60. Electrical activity of Sternarchus albifrons. Fish in lucite and nylon fish line fixture, pick-up electrodes perpendicular to the fish, distance: 40 cm, fish at 22.5° , amplitude: 100 mV/grad, sweep: 1 msec, amplifier amplification factor: x 4200.

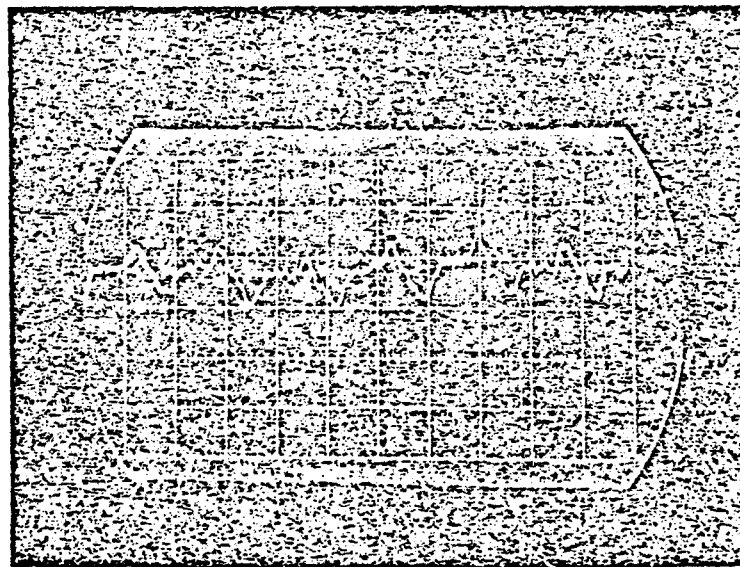

Fig. 61. Electrical activity of Sternarchus albifrons. Fish in lucite and nylon fish line fixture, pick-up electrodes perpendicular to the fish, distance: 40 cm, fish at 45° , amplitude: 100 mV/grad, sweep: 1 msec, amplifier amplification factor: x 4200.

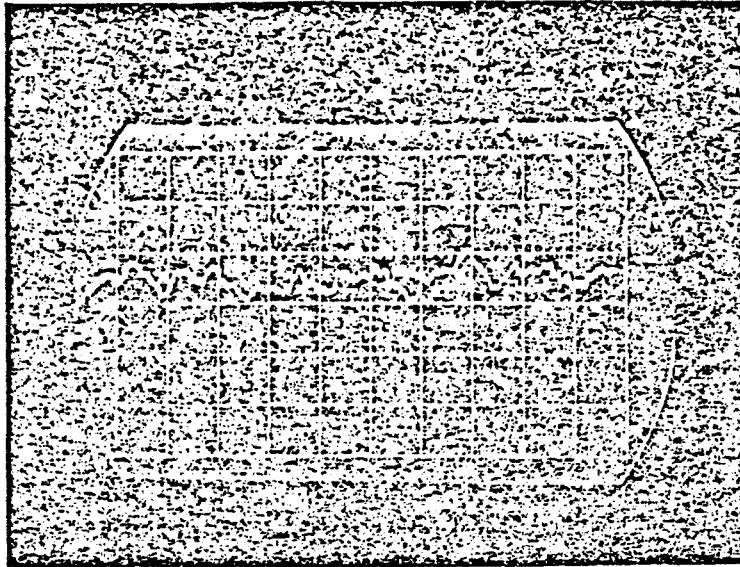

Fig. 62. Electrical activity of Sternarchus albifrons. Fish in lucite and nylon fish line fixture, pick-up electrodes perpendicular to the fish, distance: 40 cm, fish at 90° , amplitude : 100 mV/grad, sweep: 1 msec, amplifier amplification factor: x 4200.

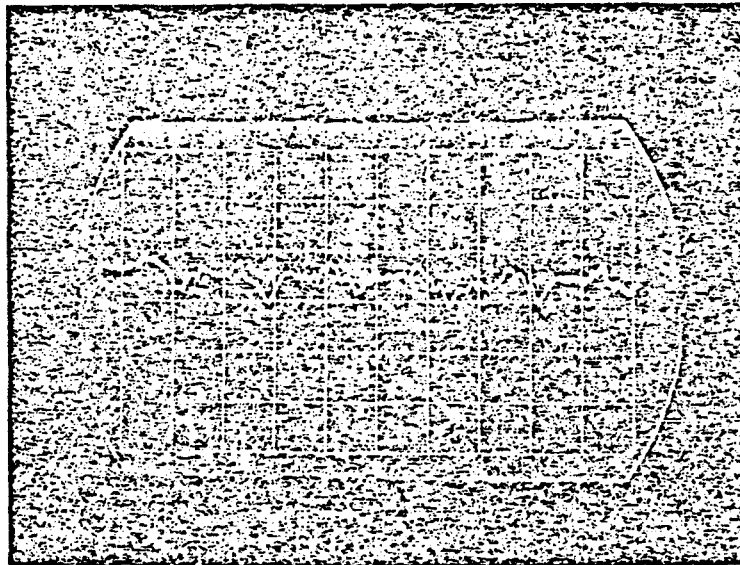

Fig. 63. Electrical activity of Sternarchus albifrons. Fish in lucite and nylon fish line fixture, pick-up electrodes perpendicular to the fish, distance: 40 cm, fish at 90° amplitude : 100 mV/grad, sweep: 1 msec, amplifier amplification factor: x 4200.

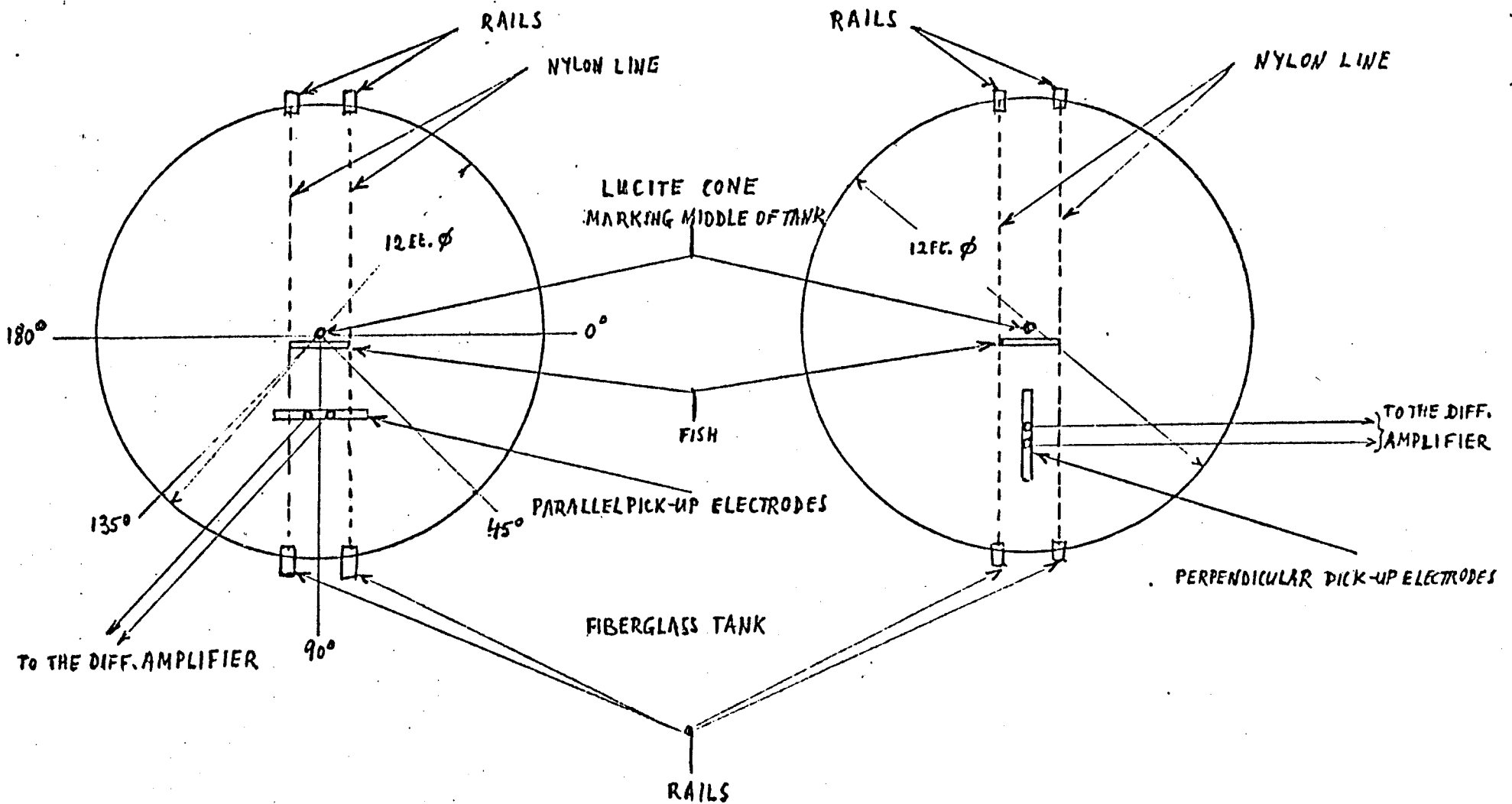

Fig. 64. Diagram of the fiberglass water tank with a fish positioned in the middle of the tank and pick-up electrodes.

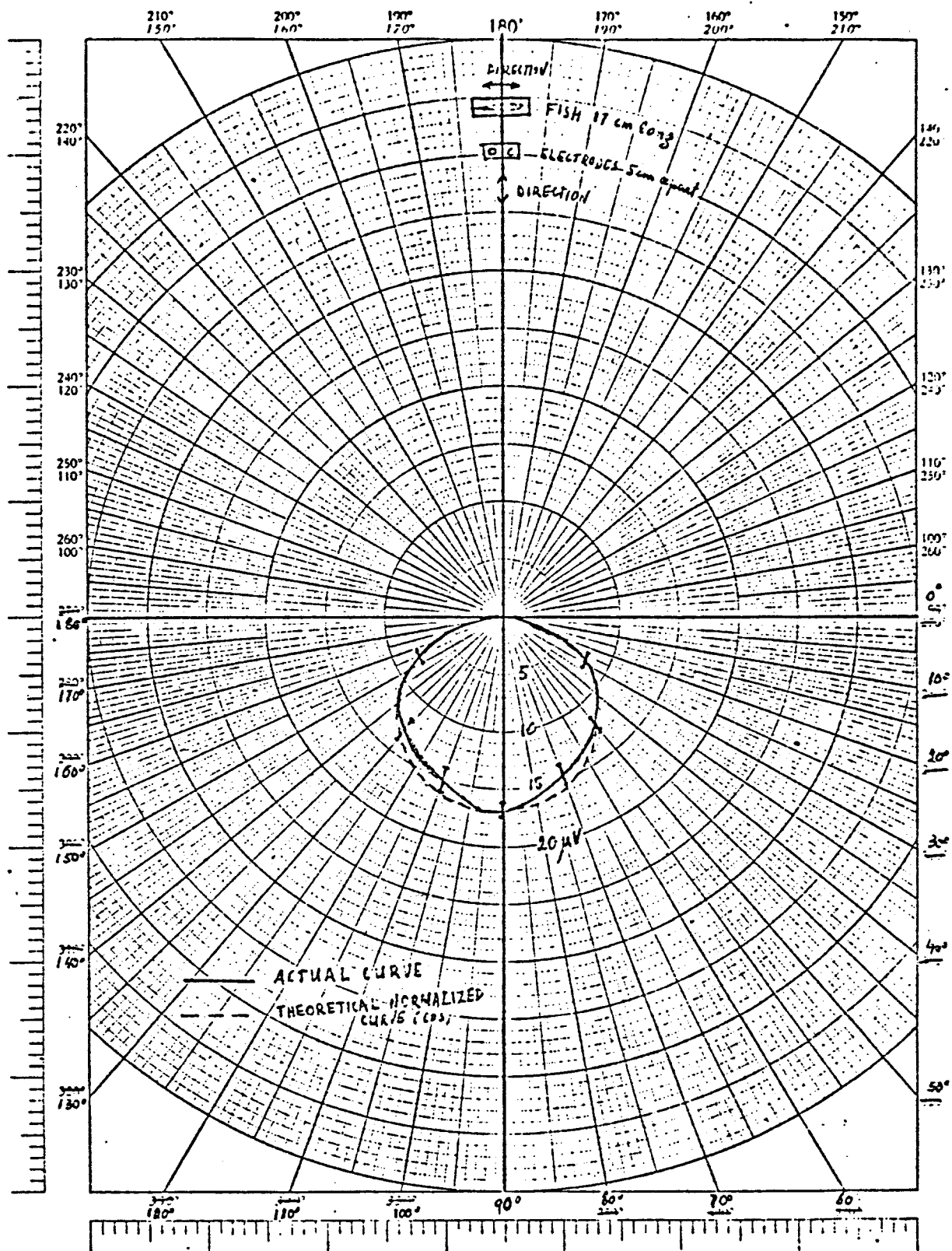

Fig. 65. Electromagnetic field-pattern of the freshwater weakly electric fish *Sternarchus albifrons*. Pick-up electrodes parallel to the field.

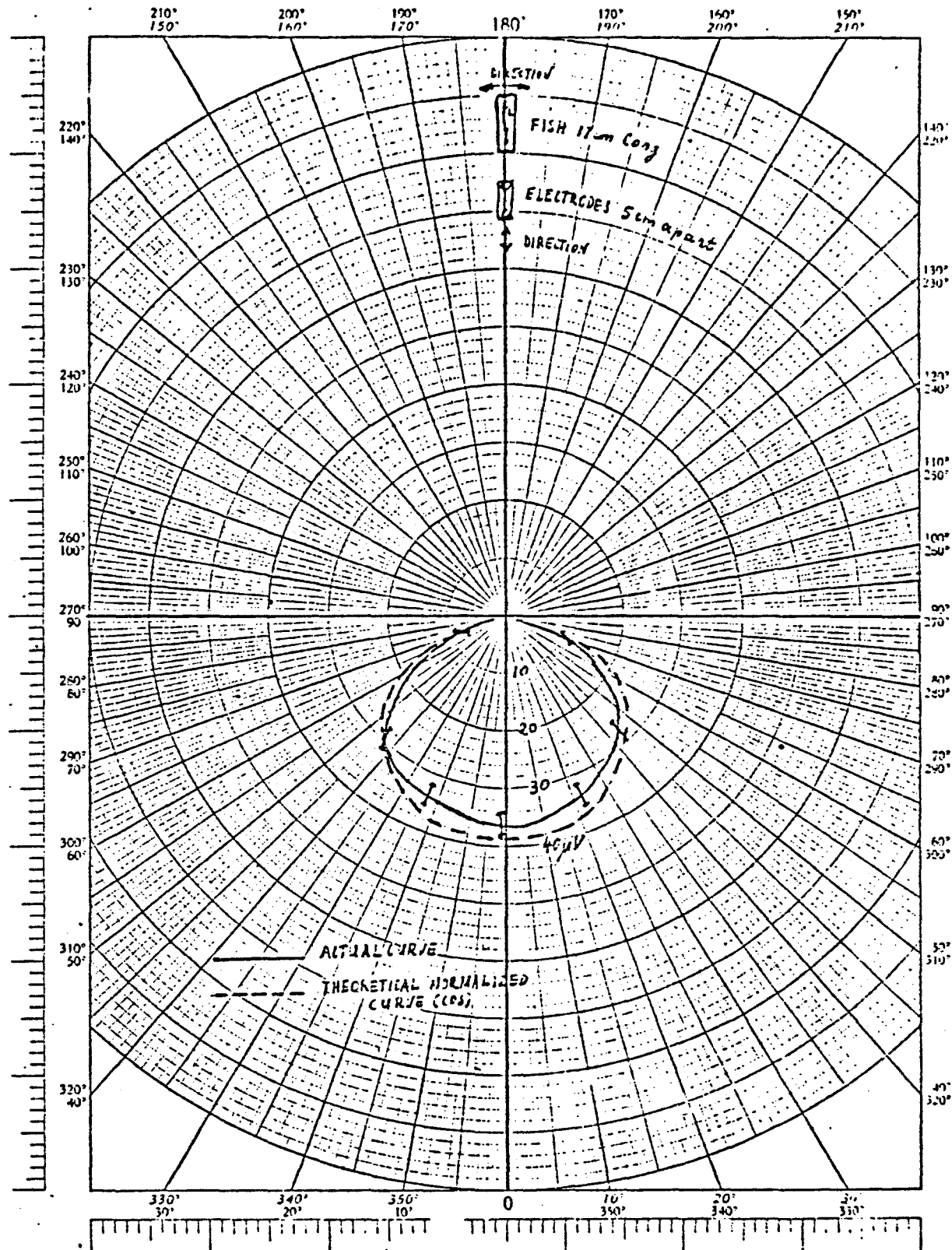

Fig. 66. Electromagnetic field-pattern of the freshwater weakly electric fish *Sternarchus albifrons*. Pick-up electrodes perpendicular to the field.

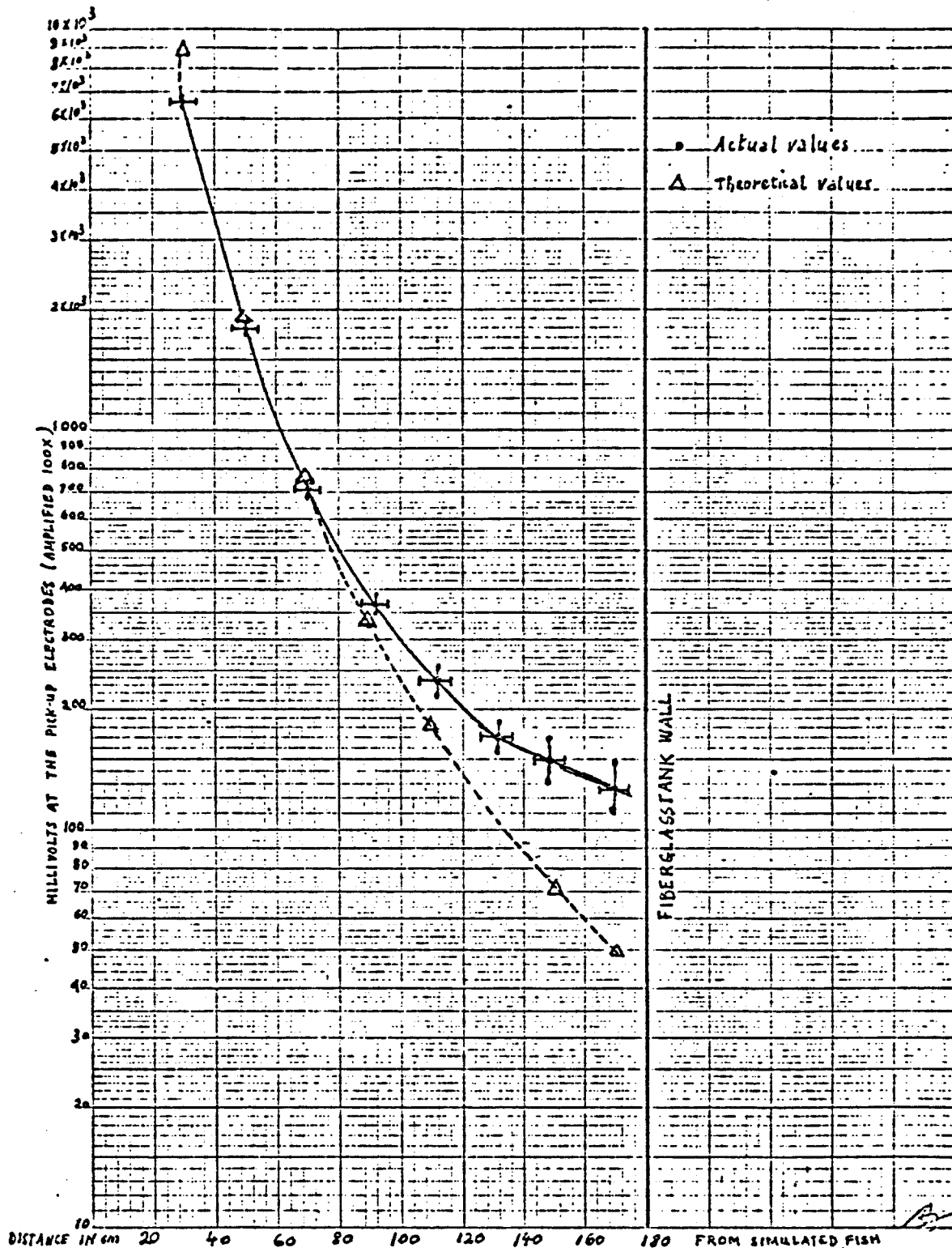

Fig. 67. *Sternarchus albifrons* (simulated) electrical signal picked-up at different distances from simulated fish and compared to the theoretical curve. Effect of the tank wall. (Boundary conditions.) Repetition rate: 720, measurements: 90° to dipole axis, electrode 5 cm apart, parallel to dipole.



Fig. 68. Permanent magnet (500 g) wrapped in polyethylene foil. It was submerged in the water to assess the ability of electric fish to detect magnetic fields.

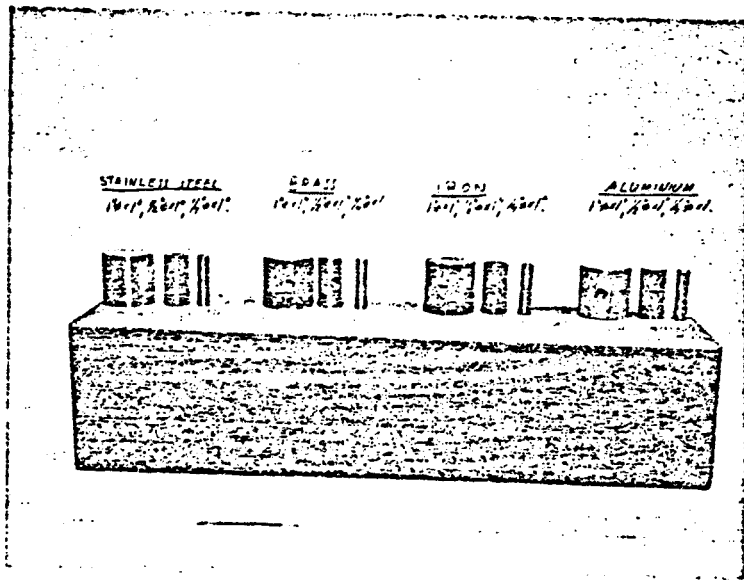

Fig. 69. Different objects (cylinders of metal) used to test the ability of electric fish to detect them. A lucite cylinder (not shown) was also used.

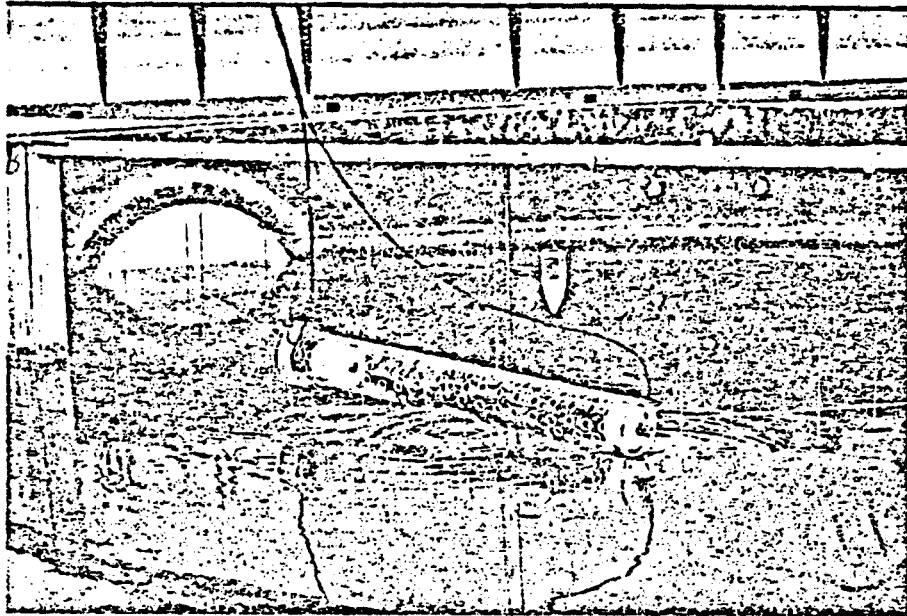

Fig. 70. Electric fish in lucite tube with holes and stainless steel end electrodes in the large fiberglass tank used to establish the threshold of detection of different objects (before lowering the tube in the water).

and to an oscilloscope. During the measurements of the electromagnetic field generated by Sternarchus albifrons, the fish was confined in the fixture of lucite and nylon fish line with an open area of 82%. The fixture was free of conducting materials.

The fish in the restraining fixture was located in the middle of the tank and could be rotated 180° . The center of the tank was constantly fixed using a lucite plumb bob suspended from the ceiling (Figs. 70 and 71). Measurements were repeated at 0° , 22.5° , 45° , 67.5° , 90° , 112.5° , 135° , 157.5° and 180° of rotation. All measurements were replicated five times. The fish was submerged to a 10 cm depth. The fish's own signal was too weak to take measurements at distances over 40 cm from the fish. Therefore, the discharge of the fish was amplified by an audioamplifier 400 x and fed into the tank by means of silver-silver chloride electrodes about 12 cm apart (equal to the length of the fish).

The fish could discharge a signal of about 22 mV at a repetition rate of 720. The resistance of the water was around 900 ohms between electrodes (12 cm distance). We amplified the fishes original signal to 7 volts when we recorded from the electrodes. In this way, we improved the signal-to-noise ratio by a factor of $7/.002$ or 350.

Measurements were made with the electrodes parallel and perpendicular to the electromagnetic field of the fish. Data was plotted on graph paper. Photos were taken with the oscilloscope camera. Figures 54 to 57 show the signal picked up by the silver-silver chloride-platinized-silver-chloride electrodes when parallel to the electromagnetic field. These oscilloscope data show the signals amplified x 4200. The smallest readable value was around 6 microvolt at the origin. The noise level was very low considering that the tank is in an open area and the room was not shielded.

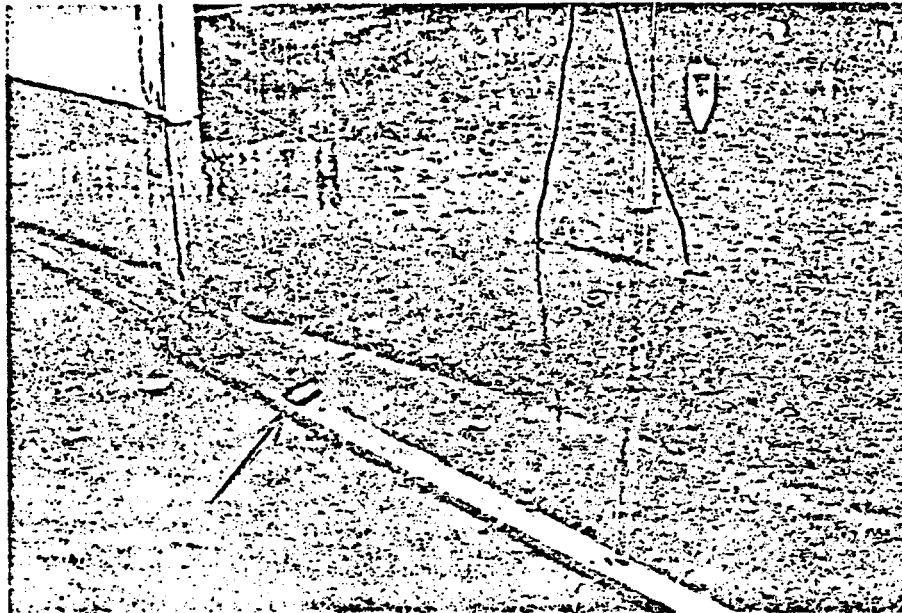

Fig. 71. Fish in a restraining cage submerged in the large tank, the lucite cone indicates the middle of the tank. Arrow indicates an object moved in the direction of the fish.

Figures 59 to 63 show the signal picked up by the electrodes being perpendicular to the electromagnetic field of the fish. All these measurements were taken with the pick-up electrodes at 40 cm distance from the fish. The fish was rotated from 0° to 90° making measurements at 0° , 22.5° , 45° , 67.5° and 90° . Figure 64 shows a diagram of the fiberglass tank including positions of the fish and of the pick-up electrodes. Figure 65 and 66 shows the electromagnetic field of Sternarchus albifrons plotted and compared with the normalized theoretical cosinus curve of a dipole, for pick-up electrodes parallel to the electromagnetic field.

Figure 67 shows the EMF values for different distances from the center of the tank.

The fish had to be restrained from moving during the electromagnetic field measurements, so as not to change the dipole direction. We experimented and checked different fixtures like: tubes with holes, lucite endplates and rods and lucite endplates and nylon fish line. They are shown in Fig. 51. The tube had 20% open surface, the lucite endplates and rods about 40% open surface and the lucite endplates and nylon fish line 82% open surface.

2.4 BEHAVIOR EXPERIMENTS FILMED ON STANDARD 8 FILM

2.4.1 Experiments Needed to Assess Sensitivity, Range and Effectiveness of the Electric Fishes to Detect Objects and Communicate Underwater

We considered it necessary to perform a number of experiments designed to quantify some of the electric fish properties. Four different species of electric fishes have been considered for these experiments because of their basically different systems used as transmitters and electroreceptors. These fishes are:

a. Gymnarchus niloticus

An African weakly fresh-water electric fish with a medium fixed frequency (260 to 300 Hz) and a composite waveform. Frequency does not change with temperature. It has about seven kinds of electroreceptors plus displacement, acoustic and chemical sensors located on or near the skin. Electroreceptors are located on the whole body but are more numerous near and on the head and near its very pointed tail. Countries of origin are Sudan, Nigeria and Ivory Coast and the two Congos of Africa. It can grow to a maximum size of 5 feet and has a life span of about 40 years.

The electric organ is located caudally occupying about 1/2 to 2/3's of the fish length. Electric organ is derived from modified muscle spindels. Difficult to obtain and to keep alive. Has strange parasitic diseases affecting the spinal cord. The fish is practically blind and has only vestigial eyes.

b. Sternarchus albifrons

A South-American weakly fresh water electric fish with a high, relatively fixed frequency (700-800 kHz) and a composite waveform. The rate of discharge is temperature dependent at a rate of between 40 to 60 Hz per degree centigrade. Has at least three kinds of electroreceptors plus displacement, acoustic and chemical sensors located on or near the skin. Electroreceptors are located on the whole body and preferentially on or around the head. Countries of origin: Brazil, Columbia, Venezuela, Guianas, Argentina, Bolivia, Ecuador, Peru in South-America and some parts of Central America. Can grow to a maximum size of one foot. Life span is at least 10 years.

The electric organ is located caudally occupying about 2/3's of the fish's body length. The electric organ is derived from modified nervous tissue. It is a hardy species, easy to maintain and easy to procure. This fish is also practically blind and has vestigial eyes.

c. Gymnotus carapo

A South American weakly fresh water electric fish with a medium to low variable frequency (30 to 150 Hz) and a composite waveform. Has multiple electro and sensory receptors located on or near the skin. Electroreceptors are located on the whole body and preferentially on or near the head. Countries of origin same as for Sternarchus albifrons. Can grow to a maximum size of one and a half feet. Life span is several years.

The electric organ is located caudally occupying about 1/2 of the fish's body length. The electric organ is derived from modified muscle spindels. It is a hardy species but is not as easy to procure as Sternarchus.

d. Gnathonemus petersii

An African weakly fresh water electric fish with a low variable pulse-form repetition rate signal (5 to 170 pps). Has multiple ampullary and tuberculous electroreceptors and sensory receptors located on the body and preferentially on or near the head. Countries of origin located in the subtropical, tropical and equatorial Africa. Can grow to a maximum size of one foot. Life span may be several years.

The electric organ is located in the tail and is derived from modified muscle tissue. It is relatively easy to procure, but is very difficult to maintain it for longer periods of time in captivity.

For all experiments we used a fiberglass water tank of 12 foot diameter and 4 foot height.

Experiment #1

This experiment was designed to assess the capability of electric fishes to use their navigation system to avoid obstacles like fine nylon thread. We used fishes of the species mentioned under (a) and (b). Gymnarchus niloticus

is an air breather and cannot be confined in a tube but it can be used in experiments with free swimming fishes. This fish was put in the tank at the point "A" (see Fig. 72). A double net divided the tank. The fish eventually moved toward point "B" and crossed the nylon maze. The reaction of the fish and the avoidance of the maze was observed and filmed. The fish species type (b) Sternarchus albifrons usually reacts with an escape to a metallic object. In this case a metallic object was used to force the fish to cross the double net. Its avoidance to the obstacles was noted and filmed. Both fishes are practically blind. The experiment was repeated using a grounded aluminum foil along the inner wall of the water tank.

Experiment #2

This experiment was designed to establish the ability of an electric fish of the species mentioned under (a) and (b) to detect metallic or non-metallic objects having different masses and introduced in the water tank at different distances from the fish. The fish was put at point "A". The object was introduced at position "B". The time until the fish detected the object was noted by observing the fish when it retracted or advanced in the direction of the object. The experiment was repeated after lining the interior of the tank with aluminum foil (see Fig. 73). The objects were made of iron, stainless steel (non-magnetic), brass and plexiglass, all of the same volume and form (cylinders of 1 in. diam. 1 in. long). The objects were fixed to a nylon thread and introduced vertically into the tank.

Experiment #3

This experiment was designed to demonstrate the ability of electric fish to detect a magnetostatic field. The arrangement was similar with Experiment #2 but instead of using an object in the water we used a permanent magnet inside the tank. Magnets of 1 KG wrapped in polyethylene

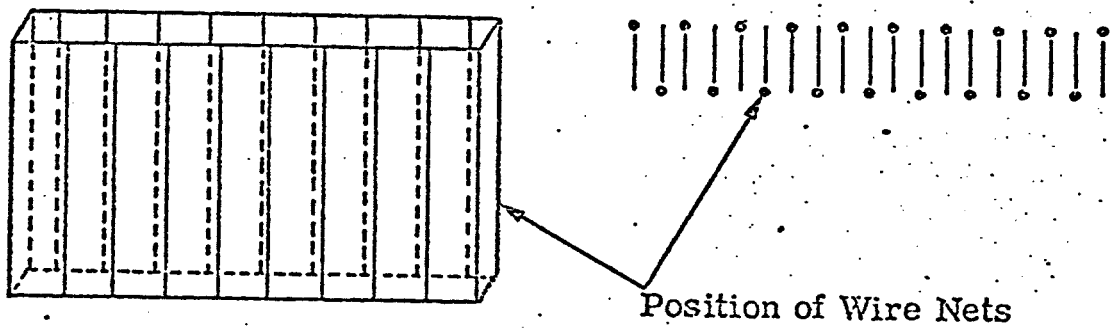
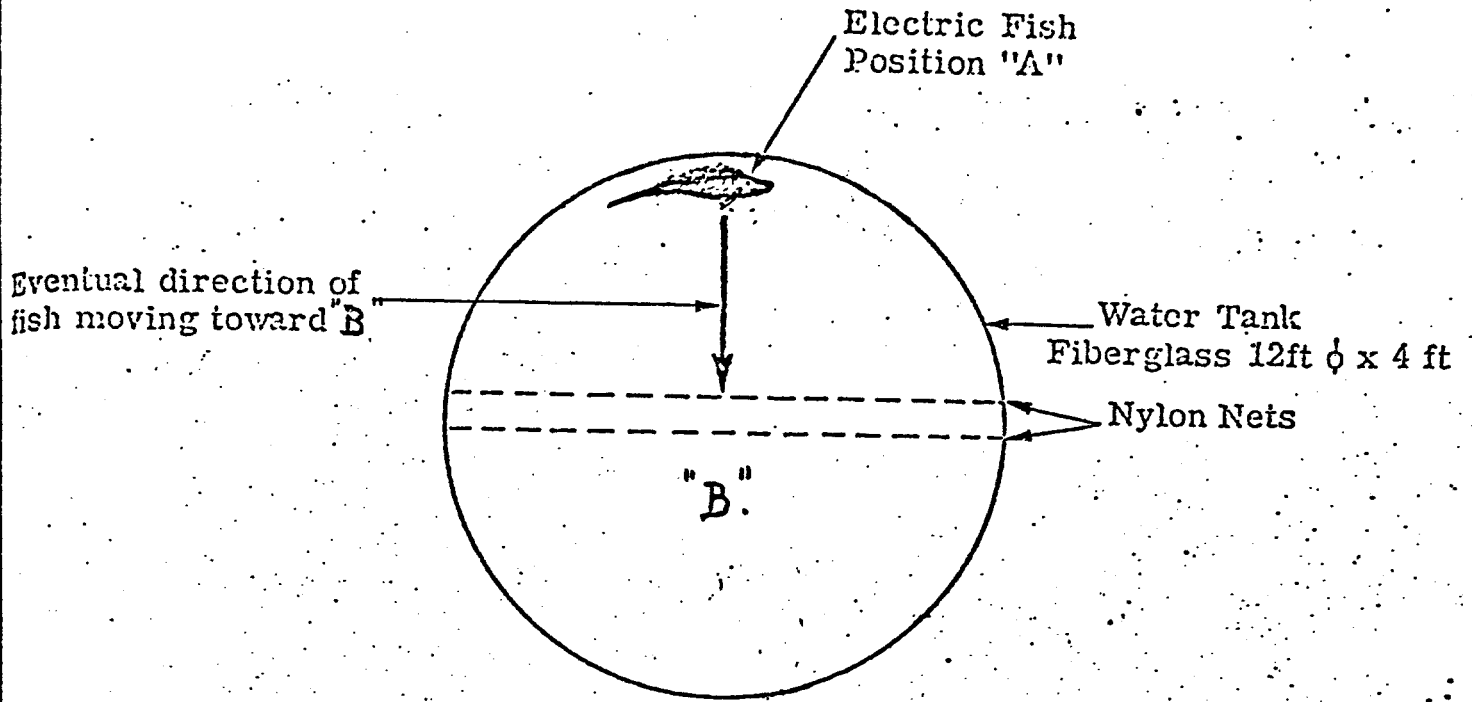

Figure 72

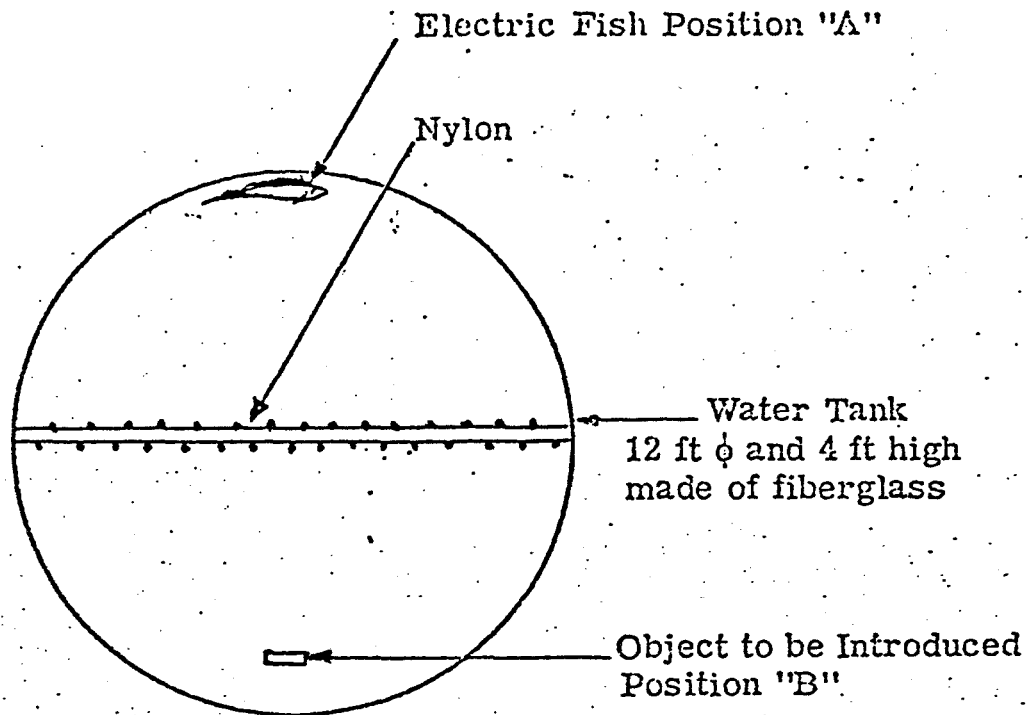

Fig. 73. The reaction time of the fish will be plotted against the same mass of different kinds of object materials.

foil were used. The reaction of the fish to the magnet was noted and filmed. The threshold of detection of the magnet by different fishes was noted. The magnet was also moved toward the fish and its reaction observed and filmed.

Experiment #4

This experiment was designed to assess the ability of electric fish to detect DC, signals (Fig. 74). The fish was positioned behind the nylon maze in the tank. Carbon electrodes were put in the tank on the other side of the maze.

Experiment #5

This experiment has been designed to relate a quantifiable parameter of the electric fish like its electric organ transmission rate to different stimuli. We used species of fish mentioned under (c) and (d). The fish were put in a restraining device and introduced in the middle of the tank. The restraining device was provided with two stainless steel end electrodes, connected to an amplifier, an oscilloscope and a frequency counter. The results were plotted, relating object, materials and distance versus repetition rate of the signal (Figs. 75 and 77).

Experiment #6

This experiment was designed to relate the ability of electric fishes to communicate underwater and the distance at which they can manage it (see Fig. 76). The signal strength of the fish was measured. The original signal was recorded with carbon electrodes on a magnetic tape recorder and monitored on an oscilloscope. This signal was played back with the same electrodes in the tank. The reaction of the fish to its own signal or to a signal of another specimen of the same species was observed and eventually filmed. Motion pictures were taken with a "Standard 8" camera, on color film (120 ft = 9 min.) and black and white film (40 ft = 3 min.) for all behavioral experiments.

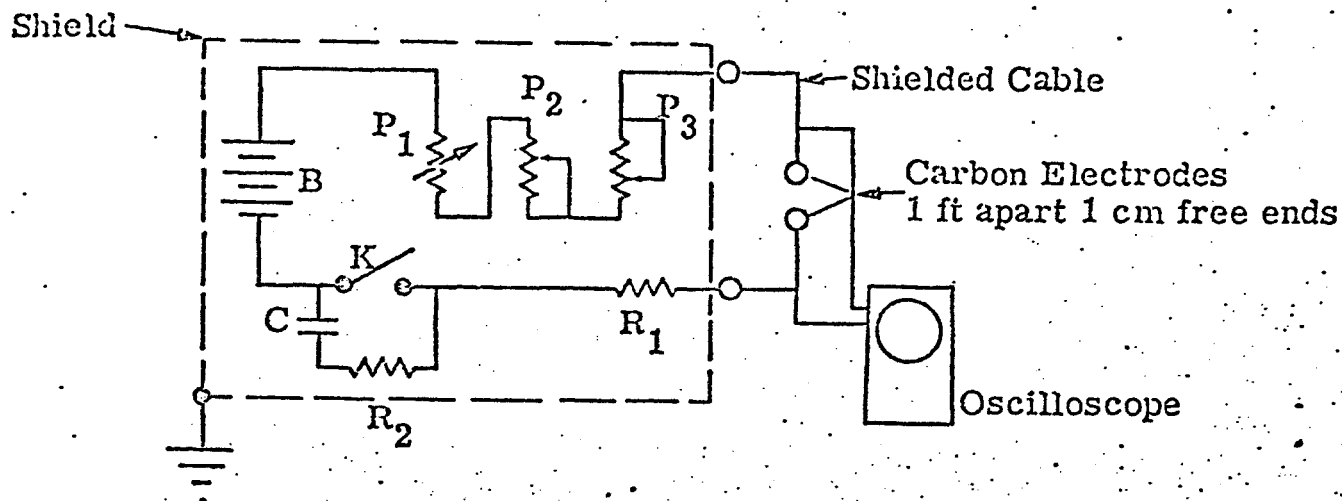

B = Battery (optimum voltage was determined by experiments and set to 6 volts)

P₁, P₂, P₃ = Potentiometers calculated to have constant impedance together with R₁ = resistor to correspond to the impedance of the carbon electrodes in water measured with the AC liquid impedance bridge

C and R₂ = capacitor and resistor to suppress sparks when the key is manipulated

k = key (telegraph type)

Fig. 74. DC signal system.

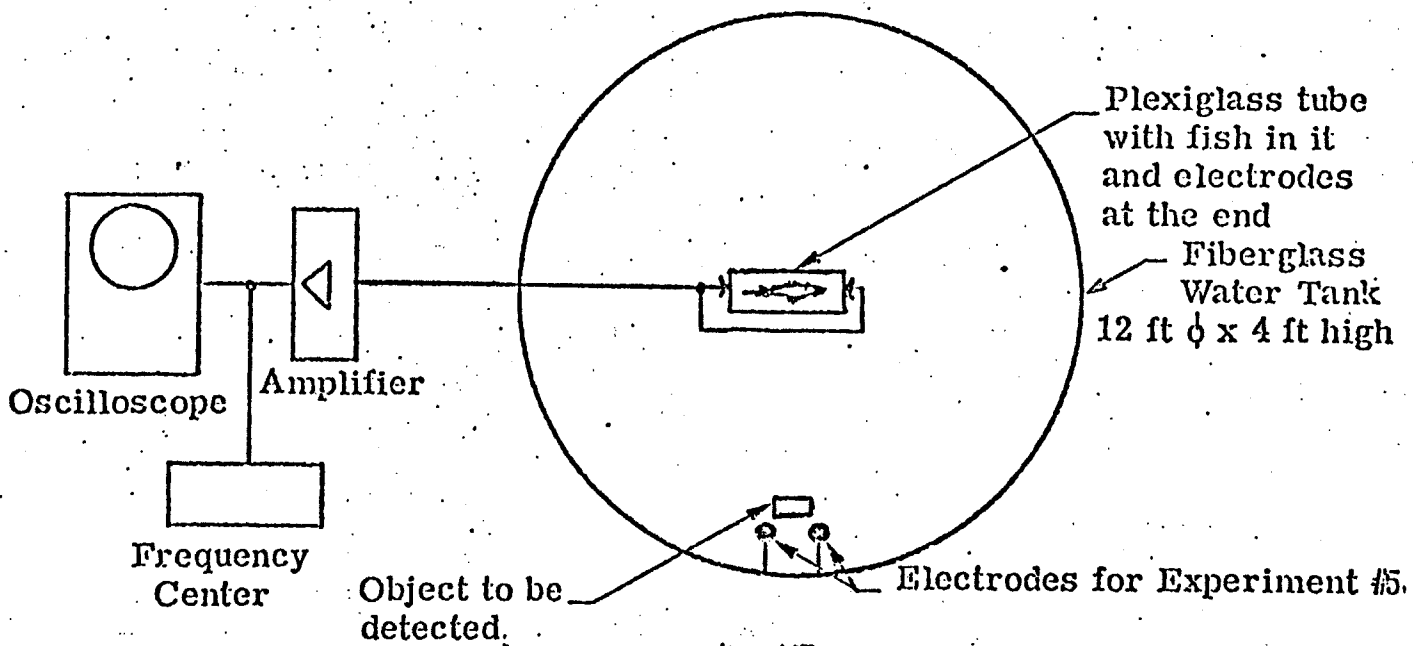

Fig. 75. Quantifiable experiment for assessing the reaction of electric fish to objects of different materials.

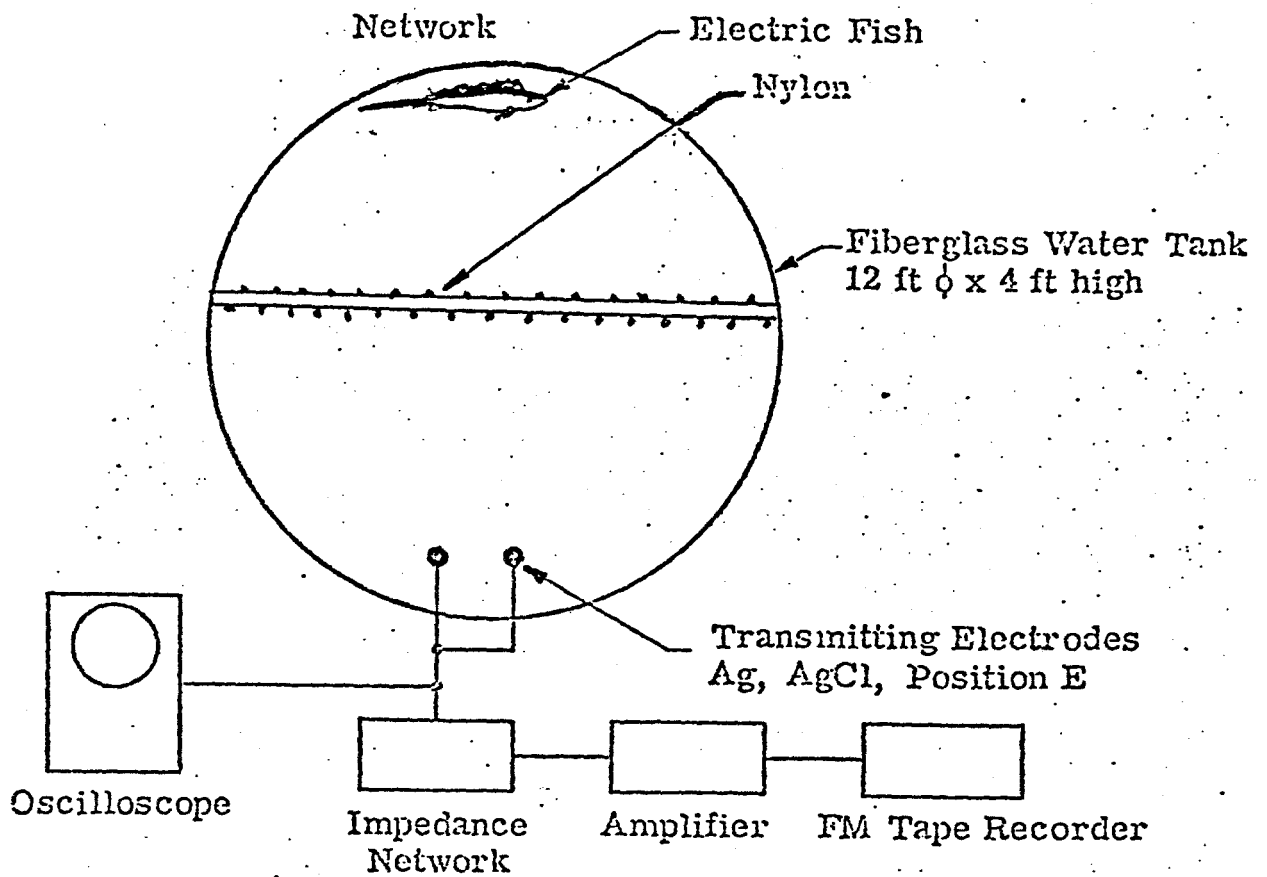

Fig. 76. Experiment devised for observing the reaction of electric fish to its own or to another specimen of the same species electric signals.

Approximately 3 minutes of film (from 120 to 75f = 45 ft) analyzes the ability of Gymnarchus niloticus, an African fresh water weakly electric fish, to swim through a double row of parallel nylon fishing lines set at 3 inches distance without touching them (Fig. 78). This species has vestigial eyes, and is blind. The movies show that the fish can pass through the lines swimming sometimes at relatively high speed both forward and backward. The Gymnarchus niloticus peculiar way of swimming can be seen and how it uses its dorsal fin in an undulating screw-like movement. This way of swimming enables the fish to hold, if necessary, the body in a straight position and make good use of the navigational and detecting ability it has due to the electroreceptors array, in its active or passive mode of reception. Another electric fish Sternarchus albifrons was introduced in the tank to demonstrate its ability to detect and interpret the electric signal of another fish of the same species (75 ft mark on film). Sternarchus has a ventral fin and uses a similar swimming technique as Gymnarchus. The fish seemed to be very disturbed at the beginning by the electric signal it received. It looks like it is attracted and then repelled. The fish undulated its ventral fin but it did not move because the ventral fins were moved back and forth in a sequential backward and forward propelling action. In this way the fish is staying in a fixed position and it looks as if it ponders to advance or to retreat: the problem it has is to decide if the signal is from a bigger or a smaller fish. The signal of Sternarchus No. 5* was recorded on magnetic tape and played back in the tank with the help of two 8 inch long, 3/8 inch thick carbon electrodes placed in the middle of the tank. The signal was amplified to a slightly higher amplitude than the original signal (100 to 500 mV).

* The same species different specimens were numbered for statistical purposes in the order we received them.

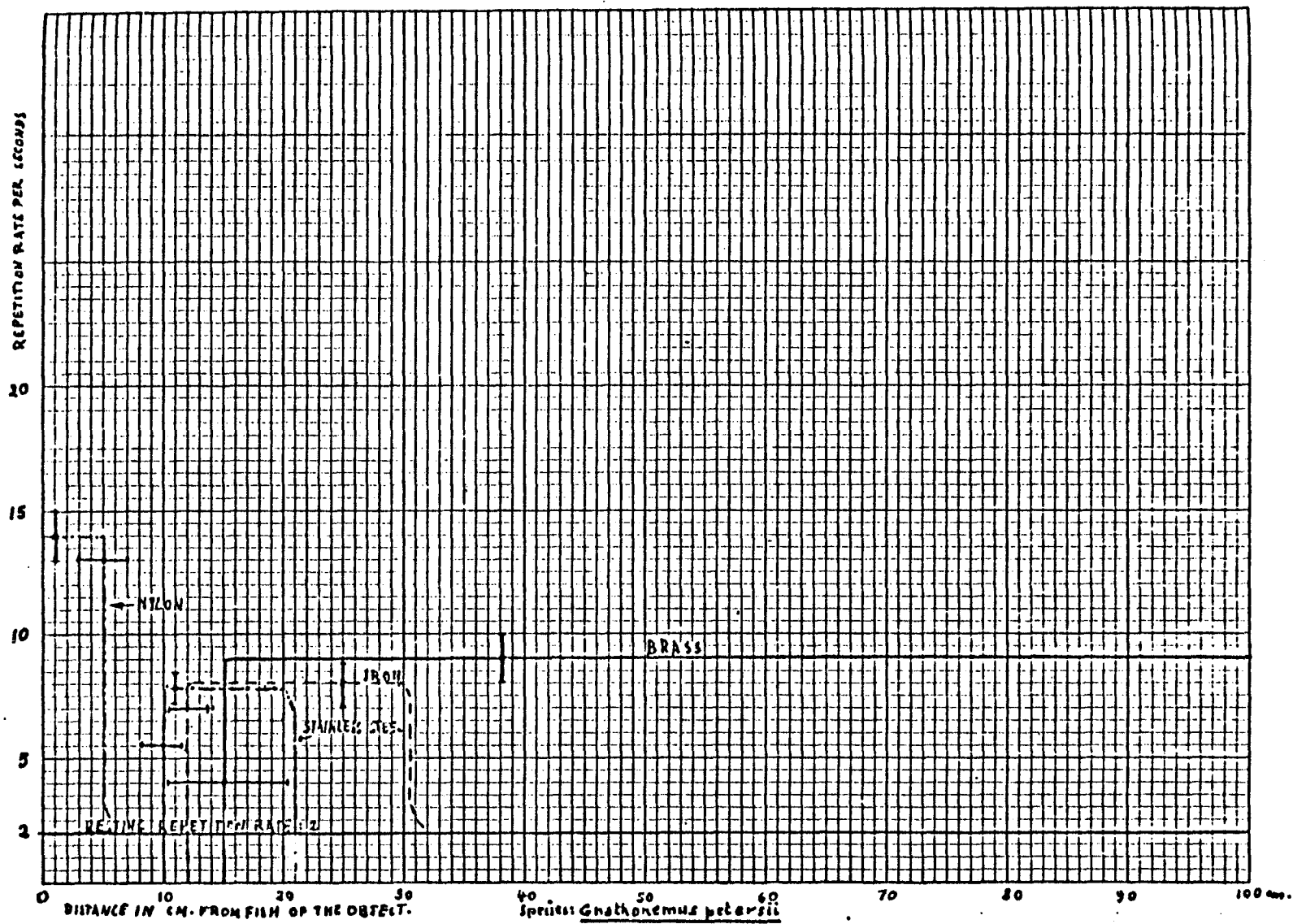

Fig. 77. Effect of different objects (1 in. ϕ by 1 in. cylinder) on the electric signal repetition rate of the electric fish Gnathonemus petersii.

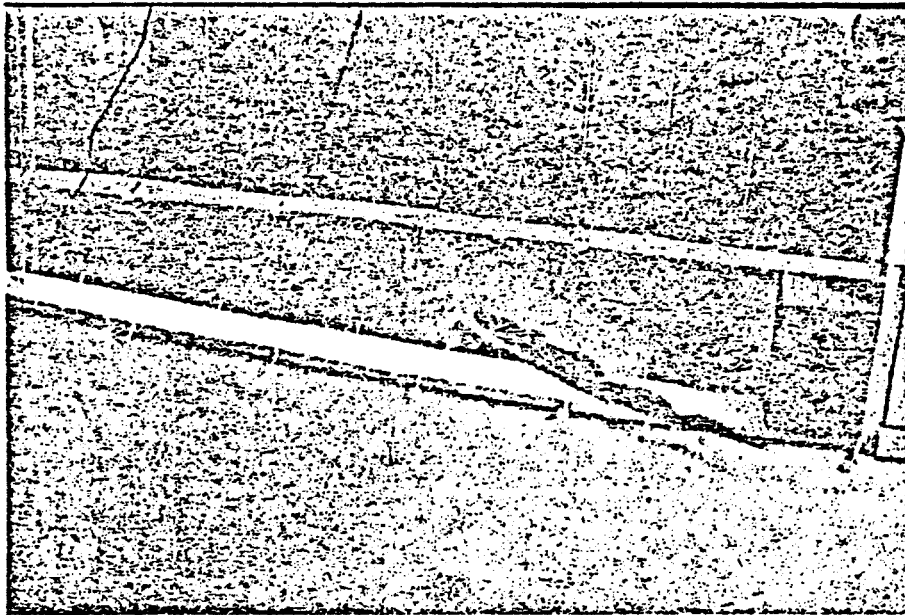

Fig. 78. Gymnarchus niloticus passes through nylon fish line maze without touching it.

The fish finally moved close to the electrodes to investigate the disturbance (at point marked ≈ 65 ft). It moved directly under the electrodes, turned around them, went on the other side of the net, returned to one of the electrodes and retracted to a far corner of the tank (≈ 55 ft point).

Gymnarchus niloticus No. 7 was introduced in the tank. The boundary conditions were changed by lining the inner wall of the tank with heavy aluminum foil (Fig. 79). The fish is investigating the tank and swims irratically from one side of the tank to the other side (≈ 40 ft point). Because the fish seemed too nervous we took it out of the tank and put it back into its normal aquarium.

Another specimen of Sternarchus albifrons (No. 5) was placed in the tank. A magnet covered with two layers of polyvinyl was lowered in the tank. The fish obviously avoided the magnet (Fig. 68) and tried to escape its magnetic field.

A piece of nylon rod about the size of the magnet and wrapped in the same polyvinyl was introduced into the tank. The fish did not appear frightened. The nylon rod could be brought very close to the fish before it slowly retreated.

A Gymnarchus niloticus No. 9 was put in the tank and the experiment with the magnet was repeated with similar results as for Sternarchus albifrons (25 feet to the end of the color film). Both fishes reacted to the magnet (≈ 1000 gauss) at over 1 meter distance.

The electrical signals of two specimens of Gymnarchus niloticus and one specimen of Sternarchus albifrons and of Gnathonemus petersii have been recorded on a magnetic tape as follows:

<u>Gymnarchus niloticus</u> N = 9:	from 50 ft to 350 ft
<u>Gymnarchus niloticus</u> N = 7:	from 375 ft to 710 ft
<u>Sternarchus albifrons</u> N = 5:	from 725 ft to 925 ft, and
<u>Gnathonemus petersii</u> N = 5:	from 940 ft to 1250 ft

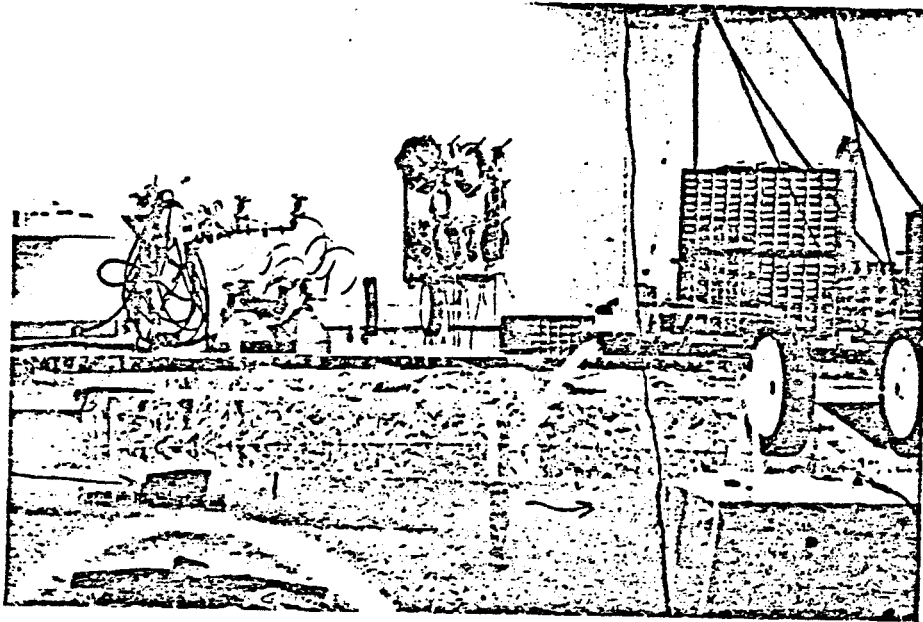

Fig. 79. Fiberglass water tank lined with aluminum foil to check out effect of boundary conditions.

The signals of both specimens were played back from the tape, amplified to its original value, and connected to two electrodes (silver chloride or carbon) immersed in the water of the big fiberglass tank. The Gymnarchus niloticus No. 7 was introduced in the tank and its behavior was filmed. The fish sensed the signal played back from every corner of the tank (maximum 180 cm). It swam under the electrodes and remained there for a while (Figs. 80 and 81). The experiment was repeated with the inner walls of the tank lined with aluminum. The fish seemed to react faster. When the signal was keyed the Gymnarchus reaction was very quick.

The two electrodes can be clearly seen at the beginning of the film. The tape-recorder can also be seen near the tank. The fish seemed puzzled at the onset of the signal and criss-crossed the tank. Then it came close to the electrodes, moved away, came close and again moved away. We played the signal at their original level and then attenuated it by 40 dB and the fish would still react to the recorded signal.

From the first and the second film we found that the electric fishes can use their electric system to navigate and communicate with each other if they are of the same species. We did all our experiments in a closed room and the electrical wiring system in it produced a very high noise compared with the received signals. The fishes were not disturbed by the high noise, because their receiving sensory system would average the noise, but not the repetitive signal of an electric fish. If the electric signal of an electric fish of a different species was played back, the signal had to be of a high level to be noticed by the subject (over 5 V at the electrodes) if the subject was far from the electrodes: < 1.5 m, and if the signal was gradually increased in strength from say 100 mV to 5 V. If the signal was keyed, the fish sometimes reacted to 1 V.

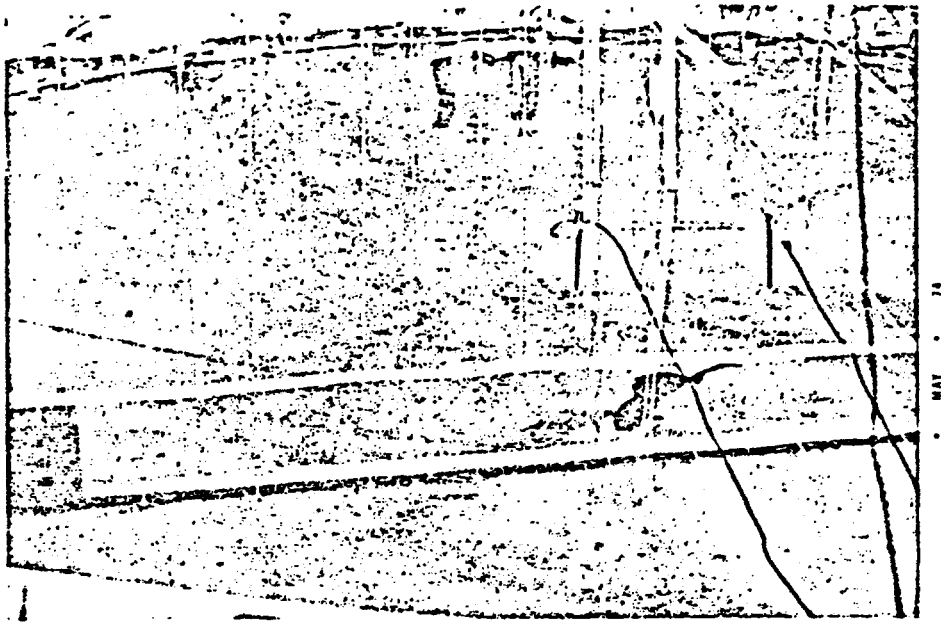

Fig. 80. Gymnarchus niloticus senses signal of another fish of the same species and directs itself toward the electrodes (carbon electrodes).



Fig. 81. Gymnarchus niloticus stays under the electrodes (silver-silver-chloride) during replay of its own signal.

We also tried keyed direct current and observed that Gymnarchus niloticus would react to impulses of less than 1 V, but it showed some habituation after ten or fifteen keyed signals at the same level. If we doubled the amplitude the fish would react again.

2.5 BEHAVIORAL EXPERIMENTS USING PHYSIOLOGICAL METHODS

Some electric fishes have a variable rate of electric signal beside changes in their amplitude. Gymnotus carapo, a fresh water South American weakly electric fish, Gnathonemus petersii and Marcusenius sp., both fresh water African weakly electric fish, belong to these species. When an object is brought in their proximity they will usually increase the rate of their signal; this increase depended on the distance from object, its size, composition, acceleration, etc. If the object comes too close to the fish, the fish may stop to transmit electric signals altogether. Cessation of signal transmission may last for seconds or minutes; if the fish does not sense any danger it will resume after a while signaling at a very low rate.

The effect of a magnet on the signal repetition rate of Gnathonemus petersii was studied. The fish was confined in a lucite tube with electrodes at each end. The fish increased the rate of the signal at a distance of 90 cm from the magnet from 2 per second to 10 per second. When it reached 20 cm from the fish, the fish stopped transmitting. Objects of stainless steel, iron, brass, aluminum and nylon, all 1 in. x 1 in. cylinders were immersed in the 12 ft fiberglass tank and their effect on Gymnarchus niloticus and Gnathonemus petersii recorded. Gymnarchus niloticus was swimming freely in the tank (Fig. 78), but Gnathonemus petersii and Gymnotus carapo have been confined in a tube as described above (Figs. 70 and 71). The electric signals of the fish were picked up by shielded cables, amplified and displayed on an oscilloscope, the repetition rate was recorded with a frequency counter.

The brass cylinder was detected by Gnathonemus petersii at a distance of 100 cm. It increased its frequency from a resting activity of 2 per second to 9 per second. When the object was brought close to the fish (between 10 and 20 cm), it stopped transmitting. The iron cylinder effected the repetition rate of the signal at 30 cm, raising it to 8 per second. The stainless steel did not affect the repetition rate until it was at 20 cm distance and then it raised it at 8 per second. The nylon cylinder was detected at 5 cm distance and then it raised the repetition rate of the input to 14 per second, it did not stop transmitting even when the nylon touched the fish.

Our findings have been summarized in Fig. 77 showing the initial increase of impulse transmission and then their cessation, using brass, iron, stainless steel and nylon.

3. CONCLUSIONS AND RECOMMENDATIONS

In the previous chapters the transmitting organs, the electroreceptor system and behavior of some African and South American electric fishes was examined. Electrical signals transmitted by electric fishes are very specific to species and subject. Coding is in many cases very complex, having two or three degrees of freedom.

Electric fishes can use their electroreceptor array in an active or passive mode for detection, location and identification purposes of underwater objects. They use their transmitting-receiving system also for species recognition and communication. From our experiments and observations we concluded that electric fishes use their electroreceptors, the other sensory receptors of the lateral line system, chemical and gustatory sensors and their hearing ability in a hybrid cross-correlating and integrating system for detection and location of objects. The Mormyrids (African electric fishes) add to this system their vision.

It is reasonable to assume that under water which is an environment difficult for communication, a cross-correlation between the signals received from different sensors as a result of different stimuli, would be more effective in a decision with regard to the nature, size, direction, speed, etc., of an object, than any of the senses taken alone.

Accordingly we recommend that the sensory system of electric fishes should be studied in detail. It is not enough to find out what kind of receptors are used in their detection ability of objects, it is essential to study what are the morphological, physiological and biochemical processes involved in

the detection of a particular object in a given environment; how are physical properties of objects distinguished, their movement, form, size recognized and how is this information integrated in the higher nervous centers.

It is also important to use a number of species having different electrical transmitting and receiving system characteristics. Besides the obvious advantages of such a detailed research for practical purposes, the results would be beneficial in tracking down effects of different obnoxious stimuli on the nervous and cellular system of man.

McGeer⁽⁶³⁾ and Axelrod⁽⁶⁴⁾ investigated the neurotransmitters in the brain. They mentioned dopamine, adrenaline, serotonin, octopamine, histamine, gamma aminobutyric acid, glutamic acid, aspartic acid and glycine. They dealt mainly with catecholamines, since more is known about these compounds than about the others. The catecholamines include noradrenaline, dopamine and adrenaline.

Acetylcholine and acetylcholinesterase also play an important role not only in the brain, but in the whole nervous and muscular system. When high quantities of acetylcholine and its ester were needed, electric eels (Electrophorus electricus) have been used to extract the chemical from their main electric organs where it could be found in high quantities. It has been done at the Columbia University, New York, Department of Neurochemistry by Dr. Nachmansohn, and more recently at NIH by Dr. Trams and Dr. Albers at the Department of Neurochemistry. Professor Waser from the Physiological Institute in Zurich is extracting the acetylcholine and acetylcholinesterase from Torpedo marmorata and I witnessed some of their experiments.

Besides the bisquaternary phosphorus compounds which are potent anticholinesterase it may be possible to produce anticatecholamines or any antineurotransmitters with catastrophic effects on the nervous system and mankind.

Not all the electric fishes use a neurotransmitter or the electric organs chemotransmitter acetylcholine-acetylcholinesterase. It can be said for sure that Sternarchus albifrons and Malapterurus electricus use other neurotransmitters. These have to be investigated and identified because they may be a prime source of another neurotransmitter than acetylcholine-acetylcholinesterase.

Narcine braziliensis is the only marine electric fish having two electric organs. The main electric organ is thought to be similar to the electric organs of other torpedos. The use of the second electric organ is not known. Because most research on location of objects and communication between fishes has been done on fresh water electric fishes, an investigation of the electric system of Narcine braziliensis may lead to very meaningful findings for marine environments.

Since we do not have all of the answers at hand with regard to the complex hybrid sensory system of fresh water and marine electric fishes, it is impossible to design and build an artificial system modeled on it. If we desire to copy something, first we have to know what we intend to copy!

REFERENCES

1. Darwin, Th, The Origin of Species, A variorum Text, Ed. by M. Peckman, University of Pennsylvania Press, Phil. (1959), pp. 350-352 (original edition: 1860 to 1872).
2. Dahlgren, U, 'Origin of the Electricity Tissues in Fishes,' Amer. Nat. 44: 193-202 (1910).
3. Garten, S., 'Die Production von Electrizedität' in Handbuch der Vergleichenden Physiologie by H. Winterstein (Ed.), Vol. 3, Part 2 (1910).
- 4.
- 5.
- 6.
- 7.
8. Szabo, Th., Nature, 194:4848:600-601 (1962).
- 9.
10. Nachmansohn, D., Chemical and Molecular Basis of Nerve Activity, Academic Press, New York (1959).
11. Meyerhoff, Otto, Zur Energetik der Zellenvorgange, Vadenhoech und Ruprecht, Gottingen, Germany (1913).
12. Vinogradov, A. P., The Elementary Chemical Composition of Marine Organisms, (Efron and Setlow, translators) Yale University Press, New Haven, Connecticut (1953).

13. Suyama, M. and T. Tokuhira, Bull. Japan Soc. Sci. Fisheries 19, 1003-1006 (1954).
14. Hasson, A. and C. Chagas, "Purification of Macromolecular Components of the Aqueous Extract of the Electric Organ (Electrophorus electricus (L)), " in Bioelectrogenesis by C. Chagas and A. P. de Carvalho, Ed., Elsevier Publ. Co., Amsterdam & New York (1961).
15. Fahn, S., R. W. Albers and G. J. Koval, "Electrophorus Adenosine Triphosphatase," Science 143:283-284 (1964).
16. Changeux, J. -P., J. Gautron, M. Israel et Th. Podleski, Neurobiologie moleculaire: Separation de Membranes Excitables a Partir de l'Organe Electrique d'Electrophorus electricus," C. R. Acad. Sci. Paris 269: 178-1701, Serie D, (1969).
17. Gautron, J., Microscope, Electron, Paris (1969).
18. Fessard, A., "Les Organes Electriques," Superclasse des Poissons, Tome XIII, Fasc. II, pp. 1143-1238, Traite de Zoologie (P. -P. Grasse Ed.) Masson et Cie, Paris (1958).
19. Keynes, R. C. and H. Martins-Ferreira, "Membrane Potentials in the Electroplates of the Electric Eel," J. Physiol., London, 119, 315-351 (1953).
20. Altamirano, M., C. W. Coates and H. Grundfest, "Mechanism of Direct and Neural Excitability in Electroplaques of Electric Eel," J. Gen. Physiol. 38, 319-360 (1955).
21. Fessard, A. et L. Tauc, "Determination Microélectrométrique du Potential de Repos de l'Élement Électrogène chez Torpedo marmorata," C. R. Acad. Sci., Paris, 233, 1228-1230 (1951).
22. Brock et coll. mentioned in Ref. 18.
23. Fatt, P. and B. Katz, J. Physiol. 118, 73 (1952).
24. Radil-Weiss, T. and N. Kovacevic, "Biophysical Parameters in the Electric Fish," Mar. Biol., Springer-Verlag, Berlin, 3, 4, 304-305 (1969).

25. Grundfest, H. and M. V. L. Bennett, "Studies on the Morphology and Electrophysiology of Electric Organs," in Bioelectrogenesis by C. Chagas and A. P. de Carvalho (Ed.) Elsevier Publ. Co., Amsterdam (1961).
26. Feldberg, W. and A. Fessard, "Cholinergic Nature of the Nerves to the Electric Organ of Torpedo," J. Physiol. 101, 200, London (1942).
27. Albe-Fessard, D. and C. Chagas, Compt. rend. 239, 1951 (1955).
28. Albe-Fessard, D., C. Chagas, A. Couceiro and A. Fessard, J. Neurophysiol. 14, 143 (1951).
29. Albe-Fessard, D., C. Chagas and H. Martins-Ferreira, Anais. Acad. Brasil Cienc 23, 327 (1951).
30. Martins-Ferreira, H. and A. Couceiro, Anais. Acad. Brasil Cienc. 23, 377 (1951).
31. Keynes, R. D., M. V. L. Bennett and H. Grundfest, "Electrophysiology of the Electric Organ of Malapterurus electricus," in Bioelectrogenesis by C. Chagas and A. P. de Carvalho (Ed.), Elsevier Publ. Co., Amsterdam (1961).
32. Johnels, A. G., "On the Origin of the Electric Organ in Malapterurus electricus," Quart. J. Microscop. Sci 97, 455 (1956).
33. Bennett, M. V. L. and H. Grundfest, "Electrophysiology of Electric Organs in Mormyrids," in Bioelectrogenesis by C. Chagas and A. P. de Carvalho (Ed.), Elsevier Publ. Co., Amsterdam (1961).
34. Aubert, X., A. Fessard and R. D. Keynes, "The Thermal Events During and After the Discharge of the Electric Organs of Torpedo and Electrophorus," in Bioelectrogenesis by C. Chagas and A. P. de Carvalho (Ed.), Elsevier Publ. Co., Amsterdam (1961).
35. Bernstein, J. and A. Tschermak, Pflüger's Arch. ges. Physiol. 112, 439-521 (1906).
36. Albe-Fessard, D. et H. Martins-Ferreira, "Role de la commande nerveuse dans la synchronisation du fonctionnement des éléments de l'organe électrique du Gymnote Electrophorus electricus (L)," J. Physiol. 45, 533, Paris (1953).

37. Agalides, E., "The Lorenzini ampulla: A Multisensory Receptor and its Possible Physical Analog," *Trans. N. Y. Acad. Sci.*, II:31:8:1083-1102 (1969).
38. Lissman, H. W., and K. E. Machin, "The Mechanism of Object Location in Gymnarchus niloticus and Similar Fish," *J. Exptl. Biology* 35, pp. 451-486.
39. Szabo, Th. and A. Fessard, "Électrorécepteurs chez les Mormyres," *J. Physiol.* 57, pp. 343-360, Paris (1965).
40. Agalides, E., "Sensitivity and Behavioral Reaction of Sharks to Electric Stimuli," Final Report ONR Contract No. 4773(00) No. 104-863, 1967.
41. Dijkgraaf, S., "Electroreception in the Catfish, Amiurus nebulosus," *Experientia* 24, pp. 187-188 (1968).
42. Murray, R. W., "Electroreceptor Mechanism," *J. Physiol.* 180, pp. 592-606, London (1965).
43. Roth, A. Z., "Electroreception in the Catfish, Amiurus nebulosus," *Vergleich. Physiol.* 61, pp. 196-202 (1968).
- 44.
45. Dijkgraaf, S., In Lateral Line Detectors (P. Cahn, Ed.), pp. 83-85, Indiana University Press, Bloomington, Indiana (1968).
46. Agalides, E., "The Lorenzini Ampulla," *N. Y. Acad. of Sci. Trans.* II 31, 8, pp. 1083-1102 (1969).
47. Harder, W., *Z. fur vergl. Physiol.* 59, 272-318 (1968).
48. Dotterweich, H., "Bau und Funktion der Lorenzinischer Ampullen," *Zool. Jahrbucher* 50 (1932).
49. Baretz, A. and T. Szabo, "Ultrastructure des cellules sensorielles," *Proc. 3rd Reg. Conf. (Eur.) Electron Microscopy*, Prague, pp. 327-378 (1968).

50. Lissman, H. W. and A. M. Mullinger, "Organization of Ampullary Electric Receptors in Gymnotidae," *Proc. Roy. Soc. B* 169, 345-378 (1968).
51. Szamier, R. B. and A. W. Wachtel, "Special Cutaneous Receptor Organs of Fish," III, *J. Morph.* 128, 261-290 (1969).
52. Szamier, R. B. and A. W. Wachtel, "Special Cutaneous Receptor Organs of Fish," IV, *J. Ultrastruct. Res.* 30, 450-471 (1970).
53. Bennett, M. V. L., "Electroreceptors" in *Fish Physiology*, Vol. 5 by W. S. Hoar and D. J. Randall (Eds.), Academic Press, New York (1971).
54. Hagiwara, S., T. Szabo and P. S. Enger, "Electroreceptor Mechanism in a High-Frequency Weakly Electric Fish, Sternarchus albifrons," *J. Neurophysiol.* 28, 784-799 (1965).
55. Belbenoit, P., "Le Role de la Decharge Electrique dans la Localization d'Objects en Milieu Aqueux chez les Mormyrides," *J. de Physiol.* 59, 4 bis, 344-345, France (1967).
56. Franz, V., "Zur Mikroskopischen Anatomie der Mormyriden," *Zool. Jahrb., Abt. Anat. Ontog. Tiere* 42, 91-148 (1920).
57. Bullock, T. H., "Seeing the World through a New Sense: Electroreception in Fish," *American Scientist*, Vol. 61, No. 3, pp. 316-325 (1973).
58. Kalmijn, A. J., "The Electric Sense of Sharks and Rays," *J. Exp. Biol.* 55, pp. 371-383 (1971).
59. Szabo, Th., "The Activity of Cutaneous Sensory Organs in Gymnarchus niloticus," *Life Sciences* No. 7, pp. 285-286, Pergamon Press Ltd., G.B. (1962).
60. Szabo, Th. and H. Sakata, "Études sur un "feedback" sensoriel participant a la régulation du rythmic des influx électrosensoriels chez des Gymnotides," *J. de Physiologie* T:59:1 bij, pp. 300-301 (1967).

61. Szabo, Th. and S. Hagiwara, "A Latency-Change Mechanism Involved in Sensory Coding of Electric Fish (Mormyrids)," *Physiol. & Behavior* 2, 331-335, Pergamon Press, London (1967).
62. Watawabe, A. and F. H. Bullock, Personal Communication to Szabo and Hagiwara in Ref. 61.
63. McGeer, P. L., "The Chemistry of Mind," *American Scientist* 59, 2, 221-229 (1971).
64. Axelrod, J., "Neurotransmitters," *Scientific American* 230, 6, 58-71 (1974).