



THE BLACK VAULT

This document was obtained from The Black Vault, an online database of declassified government documents. This particular record is housed in the MKULTRA/Mind Control Collection, a compilation of more than 20,000 pages declassified by the Central Intelligence Agency (CIA).

The entire collection is free to download and online at:

<http://mkultra.theblackvault.com>

Source of the article:

RUSSIAN JOURNAL OF SCIENTIFIC AND APPLIED
PHOTOGRAPHY AND CINEMATOPHOTOGRAPHY.

Volume 6, Number 6, November-December 1961, page 396.

Title of article:

PHOTOGRAPHY AND VISUAL OBSERVATIONS BY MEANS OF HIGH
FREQUENCY CURRENTS.

Russian authors:

S. D. Kirlian and V. K. Kirlian.

The present paper gives the results of our experiments in photography, which were carried out from the point of view of electrical and optical phenomena. We created a method of photographing under the action of high frequency currents. The principle of this method involves the transformation of the non-electrical properties of an object, the one being photographed, into electrical properties. This occurs under the action of an electric field which causes a dislocation of charges, or a transfer of charges from the object to the photographic plate or to an optical screen.

If the plates of a condenser in an oscillating circuit or generator of high frequency currents are moved apart from each other, to a certain distance, while the oscillating

164

164

circuit is activated, a high frequency field will be formed between the plates. If these plates are then moved closer to each other, and upon reaching a certain distance separating them, there will occur a high frequency spark discharge or breakdown. Such a discharge, at a particular distance separating the plates, depends upon external factors (ions, free electrons, etc.); consequently, the channels of such a breakdown discharge cannot be repeated at will.

We have been able to produce an electrical field which when placed under the correct corresponding conditions, will produce stable discharges, the channels of which are repeatable.

If the condenser plates were to be covered with a dielectric, for instance a sheet of celluloid, then under the action of the field, the dielectric itself, becoming polarized, will assume the role commonly played by the plates. The charges (resulting from displacement currents) are distributed evenly on the surface of the dielectric, which by a certain small amount exceeds the surface of the plates, or is somewhat higher than the surface of the plates.

In the case when we reduce or expand the air gap (or increase or decrease the voltage in the oscillating circuit) between the dielectric covered plates, there occurs a discharge which has entirely different characteristics from

Such a discharge will occur not at any given point of the plate but will come about over the entire polarized surface of the dielectric and will consist of a multiplicity of discharge channels.

If we were to place between the plates some kind of object, and then move the plates away from each other in such a way that between the surface of the object and the plate there should be formed a corresponding air gap, the following effect is produced: Upon applying a voltage to the surface of the object, certain electrical charges will group or cluster together. The arrangements of these charges will be influenced by the topological configuration of the object, and the dielectric structure. However, if we were to replace the dielectric, which now serves as the plate, with a photographic film (or if we were to place such a film on the dielectric) the role of the capacitor plates will be assumed by the film. The film is then polarized, and in the presence of a certain determined application of voltage, silent, stable discharges will be emitted and this emission will occur between the object and the photographic film, across the air gap and along the electrical field which has been distorted by the object. The high frequency discharges flow in both directions, or on both sides in the case of symmetrically arranged plates. Both the electrons and ions in the discharge current, while moving, act upon the photographic emulsion in analogy to the rays of light. After

... We will see in the discharge, or pro-
 jection of the electrostatic structure of the object.

In this system, we applied high gradients of potential and brought the discharge gap to its critical point of distance, just short of spark or breakdown. By so doing we created conditions under which the field intensity, independently of external causes, is in a condition to generate an emission back from the object. By this method, we obtained, under ordinary atmospheric pressure, a stable discharge in an autoelectronic form. No matter where this discharge may occur, or where it may be repeated, it will always occur from the previous point and with one and the same characteristic. Such a distribution of charges, with a subsequent ejection of these charges onto a photographic plate, we call the procedure of photographing by means of high frequency currents.

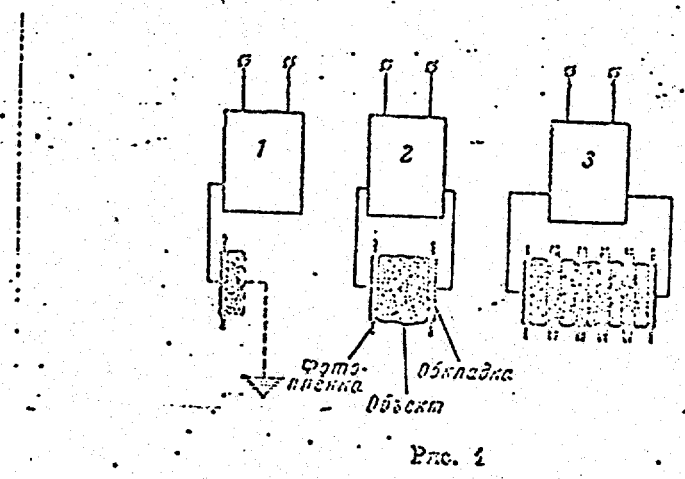

Figure (1)

In figure one, we see represented a schematic in three

parts. It shows the final result or basic arrangement of objects in an oscillating circuit of a generator of high frequency currents. In part one is shown the production of the image projection of an object, connected by space charges with ground and the generator. Part two shows a double electrode production of the image projection of an object from both its sides. Part three, shows how we can obtain ten photographs of five objects, that have been arranged in a package, by the action of one single pulse of high frequency currents passing simultaneously through all the objects.

Under these conditions, in a high frequency field, the emission images are obtained from objects having the most different properties, or possessing most heterogeneous properties (as conductors, dielectrics, semiconductors, etc.) under conditions of a very broad range of pressures.

Our investigations have shown that, in a high frequency field, all natural bodies, including living organisms, have self-radiations of an electronic and ionic nature. These we refer to as auto-electronic and auto-ionic emissions. In recent Russian literature, these radiation patterns have been named the "bioplasma fields" of living and natural bodies.

The configuration of the image projection in a high frequency field differs from time to time, even tho the object in question has a homogeneous structure. If the object has the property of conductivity, then we observe only an image

If an inanimate object (one of non-living nature) contains inclusions with capacitive and inductive values, then the density and the distribution of the discharge channels, during the formation of the image projection, is determined also by the dielectric parameters of the inclusions in question. In addition to the topographical configuration of the object, the image also represents the electrical or dielectrical structure of the complex of selective capacitances and conductivities. This structure is always constant and can be precisely reproduced in any successive photograph.

The electrical structure of a living organism; however, is not constant. It depends on the state, or varying condition of the organism. [All changes in the body's vital activities are accompanied by variations in its dielectric structure.]

In such a system, every discharge channel carries with itself a potential configuration of the corresponding segment of a field that has been formed by a certain point of the object and its characteristic. Therefore, the traversing discharge represents in its totality a group of channels which vary in density. These channels apparently comprise, in their essence, the physical; chemical, and dynamic

characteristics of the spectrum are transformed into electrical characteristics, we are then able to project them onto a photograph or a screen. These transformed characteristics produce an image which is conditioned by the geometry of the specimen, its coloring, and its internal dynamics. A biological object, which is radiating discharges, acts like a complex electrode. Therefore, it is apparent that each discharge channel has the spectrum of its bioelectrodes and of its components.

Having studied specimens with varying geometrical configurations, together with their spectrums, and their dynamics of development, [it is apparently possible to make judgements about the biological and pathological state of an organism and its organs.]

Living organisms, such as the leaf of a tree or other plant, when introduced into the electrical field of a condenser-capacitor, will distort the field according to the leaf's dielectrical structure. No matter how many different species or types of vegetation are photographed under identical conditions, each of them will display an aspect, of a very special character, that is different from the aspects of all other species. Figure two, shows how these aspects vary from leaf to leaf: Photograph (A), shows a violet, Photograph (B) represents a leaf from a corn plant, photograph (C), shows a Geranium leaf, and photograph (D), shows a verbena leaf.

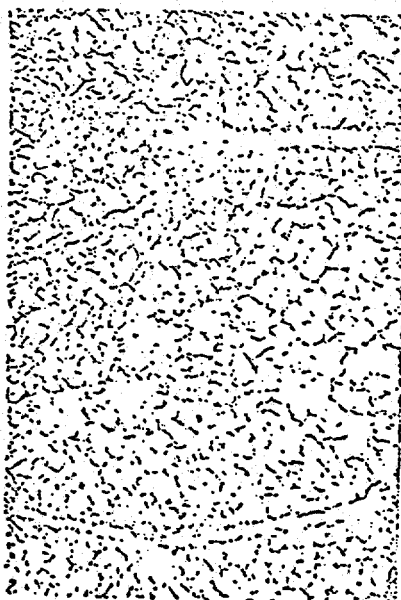
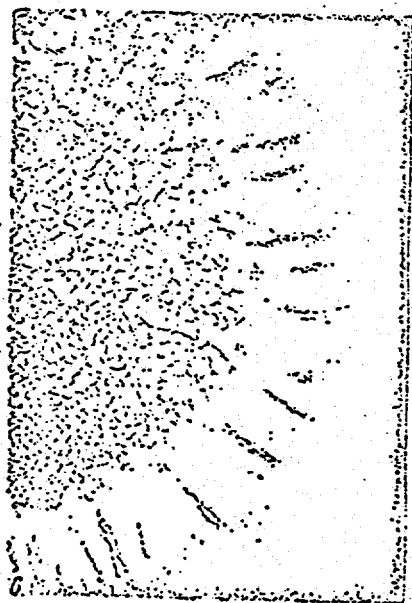
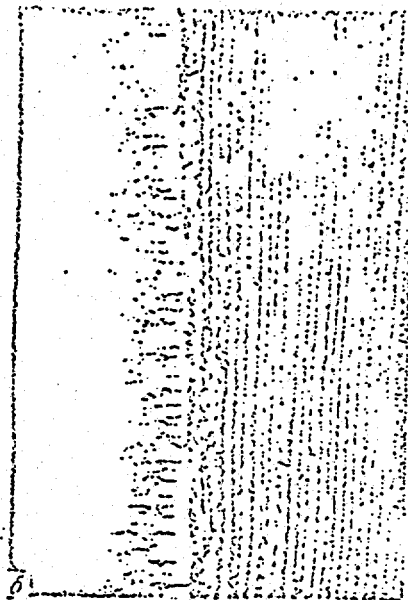
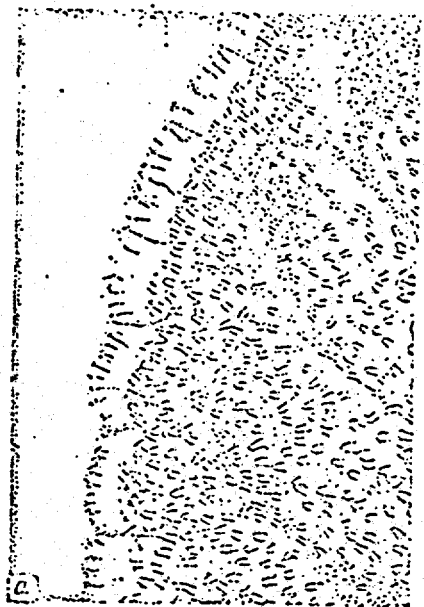

FIG. 2
Figure (2)

In the case of phytopathological changes, (diseases, dryness, drought, weathering, and aging) the leaf of a plant gives a different, highly individualized image, which characterises only a given biological condition. An illustration of this is given in figure three: Photograph (A) shows the leaf of a healthy *Agrostum*, and in photograph (B), we find the same leaf which has been allowed to wither a little.

We have shown, through practical experience, that the vital activities of a biological specimen is not upset when we make a photograph or projection of its auto-emission image.

In concluding this survey, which concerns the principles underlying the formation of image projections, it is permissible to state that the biological conditions of living objects, while being photographed and subjected to high frequency currents, are made visible by means of electrical quantities. Such an electronic-optical system is in a position to fix the topological and potential field distribution of a specimen.

Having established the connection between the image projection of a specimen's electrical state, and its physiology, it is apparent that our method of photographing, by means of high frequency currents, can be utilized in



a)



b)

FIG. 3
Figure (3)



FIG. 6
Figure (6)

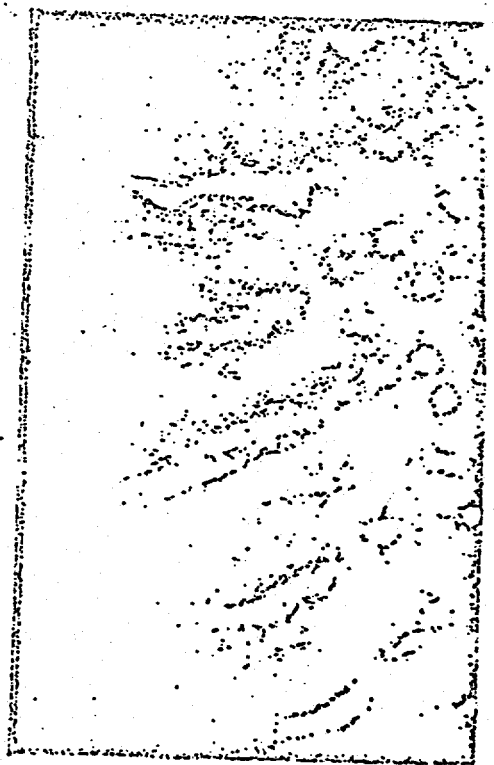

FIG. 7
Figure (7)

beneficial to agriculture and forestry. It can determine the particular condition of plants, their degree of maturity, their fruitfulness, and the phytopathological processes occurring in them.

A contact photograph must be taken in order to obtain the emission image of an object. This is done with the aid of variously constructed capacitor-condenser plates. These plates are constructed according to the specific nature of the object being experimented with. The size, or magnitude of the specimen being studied depends exactly on the dimensions of the capacitor plates and their principle of action.

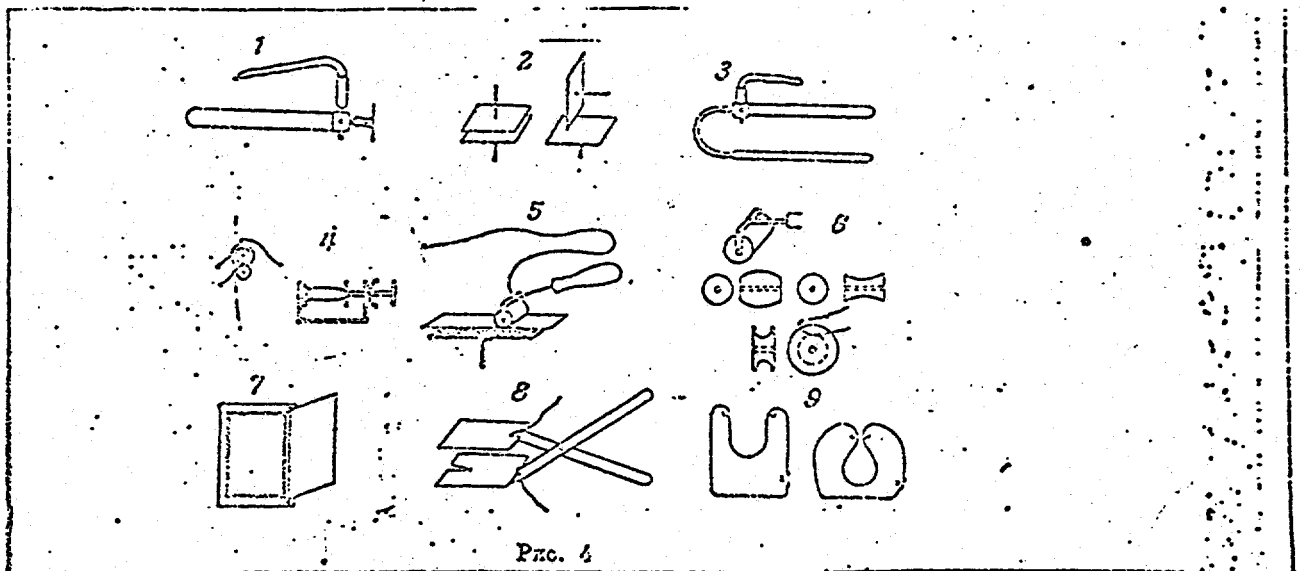

FIG. 4

Figure (4)

In figure (4), we have shown a number of various plates: part (1) is an edge view of a plate which is in the shape of

be interchanged to give us varying diameters. The photograph of a relatively thin and flat object has many details. This particular plate, equipped with a micrometer screw, gives the possibility of singling out various biological details from the same section of the sample; for example, an epidermis or outer skin layer. Part (2) shows plane, square capacitor plates. Part (3) shows two plates which are connected together by an insulating, flexible material so that the plates can be bent around to obtain images from the object or specimen. This type of plate can obtain images from the feet, hands and legs of a person. Part (4) shows a condenser or capacitor plate system. The sample, or object itself serves as a centrifugal plate. The recording of the photograph is carried out by a writing pen, combined with the plate. Part (5) shows a roller type plate, which is used to obtain a photograph of an object with a finite length. The object is photographed as the rolling capacitor plate moves past. The rollers are interchangeable and their width determines the size or dimension of the photograph. Part (6) shows an assembly or collection of rollers, or an assortment of roller type plates whose shapes are determined by the configuration of the specimens. Part (7) shows capacitor plates built in the shape of a frame; the photographs are obtained simultaneously from several wide, plane objects and simultaneously from both or either side with one impulse only. In part (8), the capacitor has been constructed in the form of pliers or pin-

position of the film, and the object are regulated by the degree of pressure created on the pincers. Thus, this type of photopincers allows us to photograph various types of flat objects. Part (9) shows soft, and flexible plates which are used to obtain image projections of the entire surface of objects having non-uniform shapes.

While photographing certain types of objects, we utilized only one plate of an oscillating circuit capacitor with a generator of high frequency currents. The other plate is actually the sample object itself, for example, a human being. During the photographic process, this plate-person is connected with ground by a capacitor current, or the person may be in a closed circuit with the generator. If we are photographing a plant, the roots can serve as the ground.

It should be noted that while using a disk shaped plate and colored film to photograph the skin of a living person, certain zones of the person's skin area are rendered by various colors. For example, the cardiac area gives a photograph with an intensive blue color, the shoulder region gives a sort of greenish-bluish color, while the hips or pelvis gives an olive colored photograph. Under equal conditions of photography, the color inherent to each bodily physical area can be repeated exactly when reproduc-

assume that, in the case of unexpected emotional experiences, (for example, fear or pain) the color usually inherent to that particular region will change also. It seems to us that these characteristic phenomena deserve some very serious study. There are apparently extremely valuable applications in the field of medical diagnosis, especially in the early stages of a disease.

With regard to a deeper investigation of the electrical phenomena and processes occurring during the photographing of the surface of a living organism, a special interest is presented by the dynamic characteristics of these processes and their connection with the biological state of the sample object. For the purpose of visually observing and fixing the dynamic development of such processes, we constructed a discharge-optical-capacitor plate. With the aid of such a device, the observation is conducted without upsetting the vital activities of the object in its natural habitat or state.

This particular condenser plate, acting in the oscillating circuit of a generator of high frequency currents, can be used as an additional device with other light-optical instruments. The principle of action of the discharge optical plate capacitor does not differ from the previously described ones. This plate has movable, or mobile details,

parts, and a pneumatic clamp is arranged which assists in making a stable connection of the plate with the sample object. This arrangement also adjusts the surface of the object while it is under visual observation.

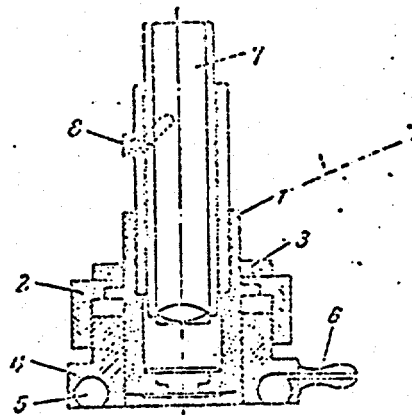

Fig. 5

Figure (5)

Figure (5) shows a schematic of the discharge optical plates. Part one, is a transparent covering, or plate covering. Part two, is a tension, or traction nut. Part three, is a locking ring. Part four, is a movable traverse member or cross beam. Part (5), is a recess groove, or hollow chamber. Part (6), is a connecting branch or sleeve which is meant for pumping out the air. Part (7), is the tube of the light-optical device. Part (8), is an adjustment for the sharpness of the image projection, or in otherwords, it is a focusing adjustment.

On the skin covering of a human being, or on the surface of other objects, both living and non-living, there are

discharge and electrical charges. Perhaps this is shown by the fact that they are located in the electrical field of the earth.

The topographical distribution and the electrical characteristics of the charges are determined by the configuration and the dielectric structure of the object of specimen. With the aid of a discharge optical device, and in the presence of a corresponding intensity of a high frequency field, the electrical charges on a polarized surface, like the epidermis of a human being, were made visible by us in the form of discharge channels. These discharge channels are intersected perpendicularly by the lines of force of the electrical field around the object. These observations of the human skin took place under a magnification of 800X.

When we consider that the arrangement for a visual observation is unipolar, and that it is fed by high frequency currents, while at the same time, the discharge channels observed on the surface of the skin, through the objective lens, are caused to converge by the capacitor current that flows toward the generator or ground, we conclude that the discharge channels apparently possess a nature which is directly related to the nature of torch-like discharges.

Let us now examine, a little closer, a certain electrical phenomena which can be observed on the epidermis of a living person. In the field of vision, and on the background of the

configuration of the skin, the skin has various discharge channels having various characteristics. Some of them are point-like, others are in the shape of a corona, others again look like torches, and various luminous clusters are noticed. These discharge channels have various shades of colors, such as light blue, sky blue, lilac, purple, and orange. Some of these colors are very bright, while others look dim, pale, and discolored. Then there are other colors which seem to be continually burning, or flaring and scintillating. So one observes periodically occurring flareups and one notices that some discharge channels are immobile while others continually move about. All of these qualitative indicators, of the discharge channels, depend on the type of activities or mechanisms contained in the human skin.

The distribution of the discharge channels is not uniform everywhere. For example, on the skin of the fingertips, there occur discharges in the form of torches which are arranged along the ductilescopic pattern of the skin as is shown in figure (6) and (7). On the forearm, the distribution or arrangement of the so called torches, form certain group like patterns which apparently are determined by the very structure of the epidermis. If we were to blot out, or erase the ductilescopic patterns, the configuration of the torches would remain and the skin pattern could be restored according to the torch pattern, or arrangement of the torches.

On certain parts of the skin, golden colored light blue points flare up. They are especially characterized by their rhythmic flare-ups and their immobility. Next to this phenomena, we observed some pale, dim clusters which probably pertain to some substance in the skin. These clusters have rather indefinite forms whose shapes are subject to change and that at times assume a spherical form. Some clusters continually spill over from one point of the skin onto another where they are absorbed. We should mention in this context that a cluster will not be absorbed until the previous one has been spilled out or over. In some cases, for example, the luminous clusters have no definite orientation in their movement. They move slowly among the torches and ultimately give off a final flare and then become extinguished or absorbed in space. The color of the clusters is either milky white, light blue, pale lilac, pale purple, or else gray orange.

In our opinion, the many fold coloration of the intermediary segments or zones of the discharge current, testifies to the fact that each system of epidermal biomechanism possess inherently its own definite coloration. It is easy to observe other characteristic phenomena in the field of vision. For instance, in the case of a high field intensity and a prolonged visual observation, (from five to ten minutes) while observing the very same segment of skin, the electrical Phenomena considerably modify their size and shape or

disappear altogether. After a rest period of about three to five minutes, or after a light epidermal refreshment, such as washing ones face with water, the previous picture is re-established. It appears to us that this method of photographic indices, (indices of the activity of biological mechanisms in the skin) open up new possibilities of investigation and documentary fixation in the domain of biology, botany and other areas of science, particularly medicine.

In concluding, we are going to give a description of condenser plates that are arranged according to an electronic / optical principle. If the sample objects have various electrical characteristics, such as those of porcelain, metal, wood, synthetic glass or plastics, are coated with a liquid dielectric such as paraffin, then when we photograph them, with the aid of high frequency currents, the photographs will reveal a recording of the configuration of those objects. These configurations occur in various densities corresponding to the dielectric parameters of each object and their spatial position in relation to the surface of the block which is covered with paraffin.

In the high frequency field, the luminescence of the paraffin block is unique. It differs from the shady irradiation caused by X-rays and does not possess any pronounced elements of fluorescence. Such luminescence is apparently determined by the capacitive and ohmic conductivity under the conditions of photography using high frequency currents.

During these experiments, the fluorescence on the surface of the block emits the impression of translucence. Experiments in this direction have shown that a polarized dielectric, in a high frequency field, may serve as an agent which transmits electrical charges from one side of its surface to the other. Thus those photographs which we obtain, with the aid of high frequency current, directly from the object, and those which we obtain through the dielectric obstacle, do not differ substantially from each other. We have come to the conclusion that this peculiarity of the dielectric can be utilized for the purpose of transmitting, across a dielectric barrier, the electrical characteristics of the object from one medium into another.

This possibility opened up a very attractive prospective, namely to enlist the services of electronic optics in order to obtain an enlarged image projection on the electrical state of the object, without having to place it in a vacuum medium.

Test involving the transfer of electrical characteristics of an object from one medium into another, across a dielectric barrier, and accompanied by a subsequent enlargement of the image projection, led us to the detection of the following effect: If, in an oscillating circuit of a generator of high frequency currents, we were to connect, instead of the capacitor plate, a fluorescing screen, situated

is an insulated block mounted on a current conducting transparent base, while in the place of the other plate, we connect the object and apply it tightly against the aperture that has been covered with a thin dielectric which is situated in the flash, opposite the screen, then we shall obtain a system of a flat or plane condenser that is structured as follows: Plate (object) dielectric-plate (in the form of a screen).

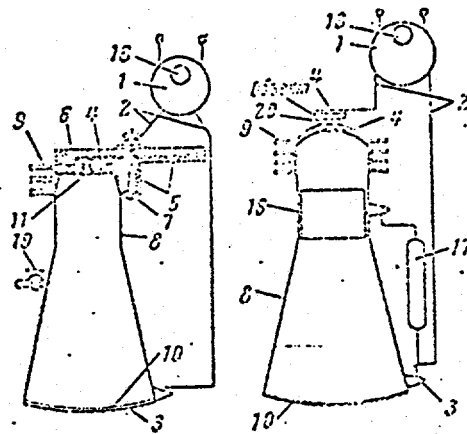

FIG. 8

Figure (8)

In the schematic of figure (8), we have presented the circuits of the high frequency condenser which is an electro-protonic optical device: Part 1, is the generator of high frequency currents, part 2, shows the electrical feeders, part 3, is the transparent current-conducting plate, part 4, is a metallic plate, part 5, is a cross beam with nests for micro-objects, part 6, is a dielectric, part 7, is the axis of the cross beam, part 8, is the flash, part 9, is a sink for current surges and serves as protection from the high frequency surface discharges, part 10,

As the pressure varies, part 17, is the aperture, the current flow into the flash and determines the magnitude of the aperture section of the plate, part 16, is an additional screening plate, part 17, is a high frequency throttle feeding the additional plate, part 18, is an adjuster of the high frequency current generator, part 19, is a valve, part 20, is the dielectric transmitting the electrical characteristics of the object from the medium, at atmospheric pressure, into a vacuum.

When in a vacuum flash, the pressure does not exceed 3×10^{-3} or does not go below 8×10^{-5} Tor (mm), and the generator operates at the normally established frequency, then on the fluorescent screen, there appears the image of the polarized object. The diameter of the screen is 240mm while the diameter of the aperture in the flash equals 1mm, see figure (8). Then the relationship of the aperture section to the area of the enclosed plate will be of the order of 1 to 240; whereby, the minimal magnification of the image will be 240 times. The degree of enlargement of the image on the screen can be increased within broad limits, by means of an additional supplemental plate, and can be regulated by shifting it along the axis of the instrument and also by changing the voltage on the supplementary plate. In this manner, by means of high frequency currents, the transmission of the image onto the fluorescent screen, in

a low pressure gas, as found not in the discharge gap between the object and the dielectric, giving a stable discharge in an auto-electronic form, but rather with the transmission of the image be performed by a selective capacitive conductivity and is actually transmitted from the medium of atmospheric pressure into the vacuum flash by pressing the object tightly against the dielectric of the flash. Under such conditions, the pattern of the electrical state of an object is projected, not in the form of electrical channels, but rather in the form of geometrical figures having varying density and dynamics. The obtaining; however, of a magnified image projection on a fluorescent screen, is implemented by varying the magnitudes of the operating areas of the condenser plates. The areas of these plates are greater in a gas of lower pressure (screen) and less at atmospheric pressure (object). While these plates guarantee, by virtue of the inhomogeneity of the field, a continuously directed movement of charges from the smaller plate to the larger plate, they also form the image projection itself.

In a low pressure gas, with the varying of the electrode areas, the directed movement of the charged particles is usually regarded as a rectifying action. We have our own point of view regarding this question. The different geometry of the electrodes in a low pressure gas, acts very much like a pump which pumps the charges from the smaller

direction to the greater irregularity of their electrical signs or polarity. Therefore, the continuously moving charges which create the image projection on the screen, alternate in accordance to their sign and at the rate of velocity of the frequency in the oscillating circuit. This circumstance gives us a justification for stating that the electronic optical devices which we have proposed are, indeed, true electronic-protonic-optical instruments.

This electronic-protonic-optical system is in a position to transmit onto a fluorescent screen the magnified image of an object's electrical or bioplasma state. This can be done without causing any physical harm to a living organism, or removing it from its natural state.

In this fashion, the procedure for photographing or projecting the image of an object on a screen, consists of contact photography, and a method for making a visual observation of the electrical phenomena taking place around a specimen, indicating the processes taking place in the specimen. This application of high frequency capacitive, electronic-protonic-optics represents a method of transforming the non-electrical phenomena of living and inanimate specimens into electrical phenomena. This method makes available, to both science and technology, a new means for the laboratory investigation which will open up attractive perspectives for the analysis and study of nature.